



# Application Tooling

Application Tooling for Cable Ties

# HellermannTyton

## Manual Tensioning Tool for Metal Ties MST-M Series

- MST9 for 8.9 mm strap width

The MST9 tool has been specially developed for reliably applying HellermannTyton metal cable ties of the MST-M Series. The punch-lock mechanism mechanically crimps the tie ensuring a reliable bundling with perfect resistance to vibration. The tension force is freely adjustable by the operator.

### Features and Benefits

- Tough metal tool
- Ergonomic design
- Consistent tensioning and automatic cutting of metal ties
- Designed for use with MST-M Series ties (8.9 mm)



MST9.

| TYPE             | Description       | Strap Width max. (G) | Strap Thickness max. | Weight  | Article-No. |
|------------------|-------------------|----------------------|----------------------|---------|-------------|
| MST9             | MST9              | 8.9                  | 0.4                  | 0.54 kg | 110-13000   |
| MST9-P29 (Blade) | Replacement Blade | -                    | -                    | 0.01 kg | 110-13001   |
| MST-9P30 (Punch) | Replacement Punch | -                    | -                    | 0.01 kg | 110-13002   |

All dimensions in mm. Subject to technical changes.

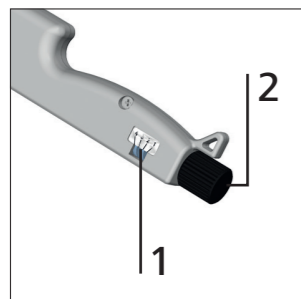

Turn the tension adjustment knob (2) until the tension indicator (1) shows the desired tension setting.

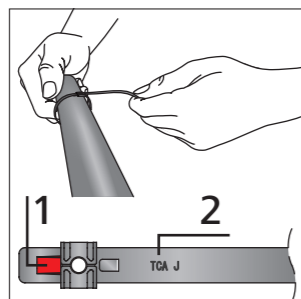

Tighten the tie by hand. Make sure that the marking TCA J (2) is facing up. MST series ties have a red mark (1) printed on the surface.

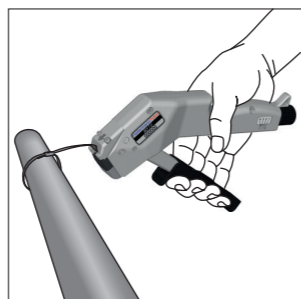

Insert the tie into the insertion slot as shown in the figure.

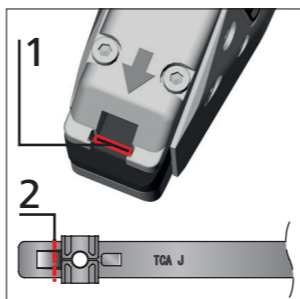

Make sure that the head of the metal tie (2) is positioned correctly within the insertion slot (1).

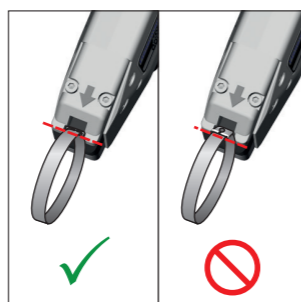

Left shows the correct position of the head. If the upper part of the head is not flush with the surface of the insertion slot, the position is not correct (right).

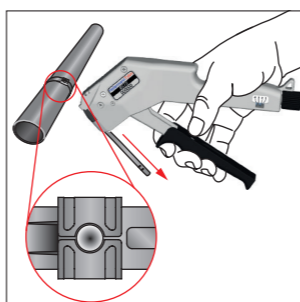

After the tension has been released, squeeze the trigger hard to cut off the end of the metal tie. When removing the tool, slide it down, away from the head of the metal tie.



One Step to the Web!



## MST-Series

Stainless steel metal ties with new punch-locking mechanism

**HellermannTyton**  
www.HellermannTyton.com

04/2015 031-93225







### Cable Ties with punch-locking mechanism

- MST-Series, Stainless Steel 304

Stainless steel cable ties are designed for fixing loads and cables securely in hazardous industrial environments such as railway carriages, jet engines, inside power plants or on offshore drilling platforms, where exposure to extremes of weather, saltwater and temperature are common. The MST-Series tie with its new punch-locking mechanism is an excellent choice especially for environments which require high resistance to vibrations.

#### Features and Benefits

- MST-Series cable ties are made from stainless steel 304
- No loosening after bundling
- Corrosion and weather resistant
- Significantly improved vibration resistance
- Outstanding chemical resistance
- Space saving solution
- Safe cut-off (no sharp edges)
- Antimagnetic
- High temperature resistant
- Non-burning



Stainless Steel Cable Ties MST-Series.

|                              |                         |
|------------------------------|-------------------------|
| <b>MATERIAL</b>              | Stainless Steel (SS304) |
| <b>Operating Temperature</b> | -80 °C to +538 °C       |
| <b>Flammability</b>          | Non burning             |
| <b>Specifications</b>        | Det Norske Veritas      |



MST tie

| TYPE    | Width (W) | Length (L) | Bundle Ø min. | Bundle Ø max. |       | Material | Pack Cont. | Application Tool No. | Article-No. |
|---------|-----------|------------|---------------|---------------|-------|----------|------------|----------------------|-------------|
| MST200S | 5.9       | 207.0      | 5.0           | 50.0          | 900   | SS304    | 100 pcs.   | 19                   | 111-01549   |
| MST360S | 5.9       | 360.0      | 5.0           | 100.0         | 900   | SS304    | 100 pcs.   | 19                   | 111-01550   |
| MST500S | 5.9       | 500.0      | 5.0           | 145.0         | 900   | SS304    | 100 pcs.   | 19                   | 111-01551   |
| MST700S | 5.9       | 700.0      | 5.0           | 205.0         | 900   | SS304    | 100 pcs.   | 19                   | 111-01552   |
| MST360M | 8.9       | 369.0      | 8.0           | 100.0         | 1,500 | SS304    | 50 pcs.    | 20                   | 111-01631   |
| MST500M | 8.9       | 509.0      | 8.0           | 145.0         | 1,500 | SS304    | 50 pcs.    | 20                   | 111-01632   |
| MST700M | 8.9       | 700.0      | 8.0           | 205.0         | 1,500 | SS304    | 50 pcs.    | 20                   | 111-01633   |

All dimensions in mm. Subject to technical changes.  
Minimum Order Quantity (MOQ) may differ from package content. Other packaging options may also be available.

| Application Tool No. |
|----------------------|
| 19<br>MST6           |
| 20<br>MST9           |

For detailed information on Application Tooling please refer to our Main Catalogue or the Internet.

**i** The MST-Series (up to 8.9 mm) can be used in combination with the stainless steel P-Mount. The mount is simple to install with a screw or bolt and ensures a durable fixing solution.

Please note! Not all products listed on this page may have this approval.

### Screw Fixing Mounts

- Stainless Steel 316 mounts

#### Features and Benefits

- 2-way fixing for stainless steel cable ties
- High performance stainless steel 316 material
- Single 4mm, 5mm or 6mm fixing hole
- Heavy duty design
- Robust and durable solution
- Resistant to a range of materials and conditions
- Quick and easy to install
- Safe and secure solution for cables, tubing, conduits and pipes
- Ideal for a range of industries and applications



Stainless Steel P-Mount SSPC.

|                              |                         |
|------------------------------|-------------------------|
| <b>MATERIAL</b>              | Stainless Steel (SS316) |
| <b>Operating Temperature</b> | -80 °C to +538 °C       |
| <b>Flammability</b>          | Non burning             |

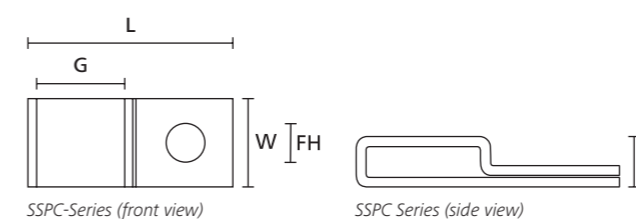

| TYPE  | Width (W) | Length (L) | Height (H) | Hole Ø (FH) | Strap Width max. (G) | Material | Colour     | Pack Cont. | Article-No. |
|-------|-----------|------------|------------|-------------|----------------------|----------|------------|------------|-------------|
| SSPC4 | 10.2      | 23.0       | 4.5        | 4.2         | 10.0                 | SS316    | Metal (ML) | 100 pcs.   | 151-00837   |
| SSPC5 | 10.2      | 23.0       | 4.5        | 5.3         | 10.0                 | SS316    | Metal (ML) | 100 pcs.   | 151-00838   |
| SSPC6 | 10.2      | 23.0       | 4.5        | 6.3         | 10.0                 | SS316    | Metal (ML) | 100 pcs.   | 151-00839   |

All dimensions in mm. Subject to technical changes.  
Minimum Order Quantity (MOQ) may differ from package content. Other packaging options may also be available.

## Application Tooling

Application Tooling for Cable Ties



### Manual Tensioning Tool for Metal Ties MST-S Series

- MST6 for 5.9 mm strap width

The MST6 tool has been specially developed for reliably applying HellermannTyton MST-Series metal cable ties. The punch-lock mechanism mechanically crimps the tie ensuring a reliable bundling with perfect resistance to vibration. The tension force is freely adjustable by the operator.

#### Features and Benefits

- Tough metal tool
- Ergonomic design
- Consistent tensioning and automatic cutting of metal ties
- Designed for use with MST-S Series ties (5.9 mm)



MST6.

| TYPE             | Description       | Strap Width max. (G) | Strap Thickness max. | Weight   | Article-No. |
|------------------|-------------------|----------------------|----------------------|----------|-------------|
| MST6             | MST6              | 5.9                  | 0.3                  | 0.525 kg | 110-61000   |
| MST6-P29 (Blade) | Replacement Blade | -                    | -                    | 0.01 kg  | 110-61001   |
| MST6-P30 (Punch) | Replacement Punch | -                    | -                    | 0.01 kg  | 110-61002   |

All dimensions in mm. Subject to technical changes.