

**RELICON** by **HellermannTyton**



RELICON – Innovative Cast Resin  
and Gel Technology

For Reliable Cable Connections





# RELICON: expertise based on experience

Innovative cast resin and gel systems for reliable cable connections.

HellermannTyton is one of the leading suppliers of products for fastening, fixing, identifying and protecting cables and their connecting components.

We also develop pioneering systems in the field of data and network technology. Our corporate philosophy focuses on customers and their need for the best possible solutions around cable management. RELICON branded cast resin and gel systems are highly innovative premium products designed to fulfil the highest expectations. RELICON products extend HellermannTyton's insulation and protection portfolio with leading cable connection technology. Relicon products deliver outstanding performance with quality you can rely on.

Part of what makes HellermannTyton a market leader is our pioneering spirit coupled with the technical expertise to continuously anticipate future demands and to answer these challenges with optimal product solutions.

# RELICON by HellermannTyton



**Cast Resin Technology**  
Page 5



**Gel Technology**  
Page 37



**Accessories**  
Page 57





## RELICON: reliably connecting the present and the future

We believe in our products. The promise they deliver is anchored in our brand name: RELICON stands for "reliable connection". You can trust RELICON to make reliable connections between today's needs and tomorrow's possibilities. A reliable connection between companies' goals and the interests of the environment. A reliable connection between efficient manufacture and optimal use.

RELICON has rapidly grown into a respected brand in the electrical installation market. Applying our longstanding engineering expertise, we develop and produce high quality cable connection products for medium and low voltage applications and contribute significantly to electrical network reliability. We supply the market with leading cast resin and gel products and a complete range of application accessories.

RELICON branded products are state-of-the-art and combine technical expertise with exceptional quality.

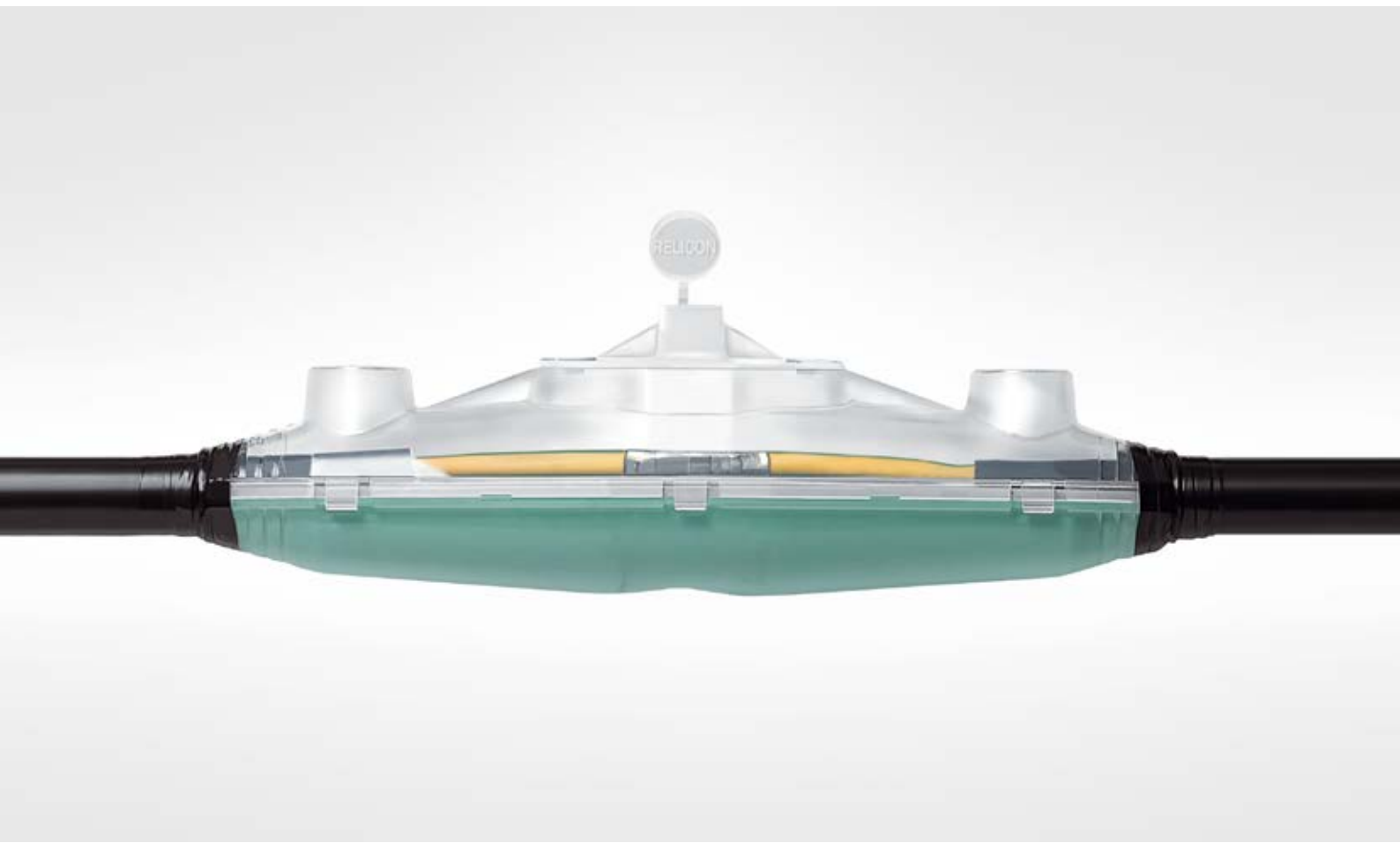

### Cast Resin Technology

<b>Straight-through joint</b>		
without connectors	RELICON i-Line SF	8
with connectors	RELICON i-Line Premium SF	9
<b>Flexible straight-through joint</b>		
	RELICON F-Line SF	10
<b>Branch joints</b>		
	RELICON Y-Line SF	11
	RELICON T-Line SF	12
<b>Parallel branch joint</b>		
	RELICON PAH-1	13
	RELICON PAH-2	14
for house connections	RELICON PAH-3	16
	RELICON PAH-4	18
	RELICON PA-11	20
	RELICON PA-12	22
	RELICON PA-13	24

### Two-component polyurethane cast resin

RELICON PUR 33	28
RELICON PUR 66	29
RELICON PUR 771	30
RELICON PUR 44 Flex	31
RELICON PUR 112 FR	32

### Two-component epoxy resin

RELICON EP 64	33
RELICON EP 20	34

### Two-component cold casting compound

RELICON Reliflex	35
------------------	----

### Two-component polyurethane sealing mastic

RELICON PUR DS	36
----------------	----



## RELICON cast resin technology by HellermannTyton

Cast resin cable joints are applied wherever cable and wiring connections are submersed or buried underground.

Cast resin joints are exposed to high stress, so the cured two-component cast resin must deliver reliable long-term mechanical protection against external influences on the cable connection.

RELICON cast resin cable joints create reliable connections in the ground. They protect cables from thermal stress, moisture and dust. They are resistant to all environmental influences and are ecologically safe. RELICON supplies polyurethane (PUR) cable joints suitable for universal use in the majority of applications scenarios. Epoxy resin (EP) cable joints are available for chemical and oil processing industries.



RELICON Safe Filling (SF) technology.





## RELICON SF technology: safe and easy filling

The special "Safe Filling" (SF) system makes RELICON cast resin joint products a pleasure to work with.

When followed correctly, SF ensures that any hazardous contact with the cast resin can be avoided and the fitter has visual control of the mixing and filling steps at all times.

Resin and hardener are mixed in a transparent double-chamber pouch. The mixture can be easily poured into the joint sleeve once the supplied nozzle is securely pressed onto the adapter ring in the pouch. The transparent cable joint parts guarantee that the fitter can visually control the entire filling process. The hydrophobic (dewatering) cast resin is environmentally safe. The mixture can be disposed of as regular household waste.

Excellent hydrolytic stability makes RELICON cast resins particularly suitable for reliable long-term applications.



*Transparent 2-chamber pouch for an optimized visual inspection of the mixing process.*



*The middle cold seal between the resin and hardener component opens by means of pressure.*



*Simple mixing of the two components.*

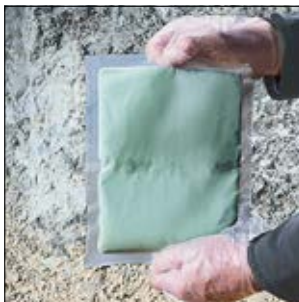

*The patented color change gives the correct mixing process.*



*Automatic and leakproof opening of the pouch through installation of the filling nozzle.*



*The filling nozzle in combination with the adapter makes filling the joint very easy and efficient.*



### Straight-through joint without connectors

#### RELICON i-Line SF

RELICON straight-through joints are made for installations in low-voltage electrical networks. They are suitable for jointing on polymeric cables and wires made of PVC, XLPE, PE, EPR and utility cables.

Application: Underground, submerged, outdoor, indoor and wiring ducts.

#### Features and Benefits

- Two-part, impact-proof, transparent moulding shells
- Compact, optimized dimensions
- Standard cable diameters indicated on the shells
- Safe-Filling system (SF)
- Immediately ready for use
- Longitudinally and transversely watertight
- Joint can be cast under influence of water

#### Content of Set / Kit

- Cast resin PUR 33
- Two-chamber pouch, transparent
- Moulding shells, transparent
- SF-system and nozzle
- Protective gloves, emery cloth, installation instructions
- HelaTape PVC insulating tape
- Spacer for max. 5 core cable (i-1 to i-4)

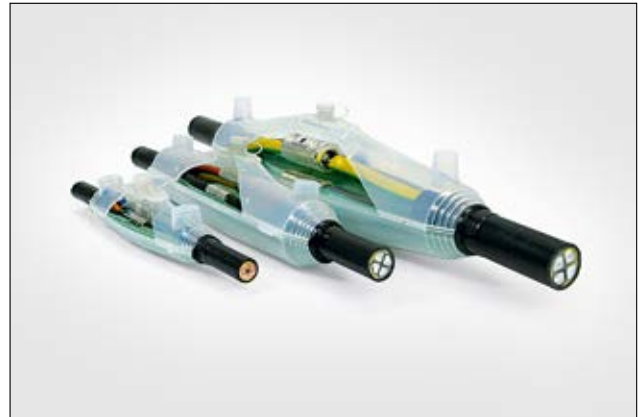

Straight-through joint i-Line SF (safe filling).

<b>MATERIAL</b>	Polyurethane resin 33 (PUR33)
<b>Colour</b>	Green (GN)
<b>Operating Temperature</b>	-25 °C to +120 °C
<b>Storage Temperature</b>	+4 °C to +40 °C
<b>Shelf Life</b>	48 months

**RoHS** ✓

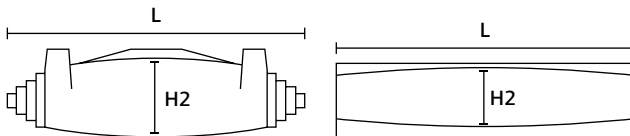

i-Line (i-0 - i-6)

i-Line (i-7)

**i** Without connector!

TYPE	Ø Main Cable	Main Cable mm <sup>2</sup> min - max		Length (L)	Height (H2)	Resin Quantity	Article-No.
i-0 / SF	7-16	3 x 1.5	5 x 2.5	182.0	25.0	95 ml / 130 g	435-12019
i-1 / SF	8-24	3 x 1.5	4 x 10 / 5 x 6	190.0	36.0	165 ml / 226 g	435-12000
i-1.5 / SF	8-24	3 x 1.5	4 x 16 / 5 x 10	215.0	39.0	220 ml / 301 g	435-12001
i-2 / SF	14-30	5 x 1.5	4 x 25 / 5 x 16	276.0	49.0	400 ml / 548 g	435-12002
i-3 / SF	23-35	5 x 10	4 x 50 / 5 x 35	360.0	54.0	655 ml / 897 g	435-12003
i-4 / SF	28-47	4 x 25	4 x 95	400.0	69.0	1140 ml / 1562 g	435-12004
i-5 / SF	33-55	4 x 50	4 x 150	520.0	100.0	2 x 1450 ml / 1987 g	435-12005
i-6 / SF	48-70	4 x 150	4 x 240	700.0	128.0	4 x 1640 ml / 2247 g	435-12006
i-7 / SF	55-77	4 x 185	4 x 400	870.0	140.0	5 x 1950 ml / 2672 g	435-12007

All dimensions in mm. Subject to technical changes.  
Minimum Order Quantity (MOQ) may differ from package content.

For product specific approvals please contact us under [www.HellermannTyton.com](http://www.HellermannTyton.com)



## Straight-through joint with connectors

### RELICON i-Line Premium SF

RELICON Premium straight-through joints are provided with an integrated connector block and made for low-voltage electrical networks. They are suitable for jointing on polymeric cables and wires made of PVC, XLPE, PE, EPR and utility cables.

Application: Underground, submerged, outdoor, indoor and wiring ducts.

#### Features and Benefits

- Two-part, impact-proof, transparent moulding shells
- Compact, optimized dimensions
- Standard cable diameters indicated on the shells
- Safe-Filling system (SF)
- Immediately ready for use
- Longitudinally and transversely watertight
- Joint can be cast under influence of water
- Connectors for aluminium and copper conductors
- Safe connection for up to 5 core cables

#### Content of Set / Kit

- Cast resin PUR 33
- Two-chamber pouch, transparent
- Moulding shells, transparent
- SF-system and nozzle
- Protective gloves, emery cloth, installation instructions
- HelaTape PVC insulating tape
- Connector block with 5 screw connectors incl. allen key

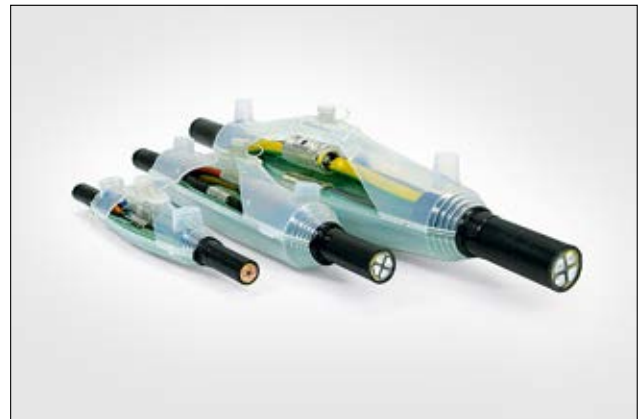

Straight-through joint i-Line SF (safe filling).



SV-Connector blocks.

<b>MATERIAL</b>	Polyurethane resin 33 (PUR33)
<b>Colour</b>	Green (GN)
<b>Operating Temperature</b>	-25 °C to +120 °C
<b>Storage Temperature</b>	+4 °C to +40 °C
<b>Shelf Life</b>	48 months

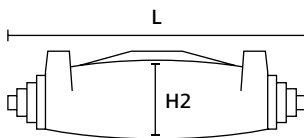

i-Line Premium

**RoHS** 

**i** With connector!

TYPE	Ø Main Cable	Main Cable mm <sup>2</sup> min - max		Length (L)	Height (H2)	Resin Quantity	Article-No.
<b>i-1 Premium SF</b>	8-24	3 x 1.5	5 x 6	190.0	36.0	165 ml / 226 g	435-12020
<b>i-2 Premium SF</b>	14-30	5 x 1.5	5 x 16	276.0	49.0	400 ml / 548 g	435-12021
<b>i-3 Premium SF</b>	23-35	5 x 6	5 x 35	360.0	54.0	655 ml / 897 g	435-12022

All dimensions in mm. Subject to technical changes.  
Minimum Order Quantity (MOQ) may differ from package content.



### Flexible straight-through joint

#### RELICON F-Line SF

The flexible RELICON F-Line straight-through joint for low voltage applications can be used to repair and connect flexible cables made of PVC, PUR, EPR like H05RR-F, H07RN-F, etc.

Application: Cable drum, underground, submerged, outdoor, indoor and wiring ducts.

#### Features and Benefits

- Reelable and permanently flexible also at sub-zero temperatures
- Very good adhesion even under permanent bending stress
- Quick and easy installation
- Immediately ready for use
- Longitudinally and transversely watertight
- High abrasion resistance
- Resistant to alkaline earths, chemical influences and UV-radiation

#### Content of Set / Kit

- PUR 44 Flex cast resin
- Two-chamber pouch, transparent
- Moulding shells with accessories
- SF-nozzle
- Protective gloves, emery cloth, installation instructions
- HelaTape self-amalgamating tape
- Cleaning cloth, plastic fabric strips

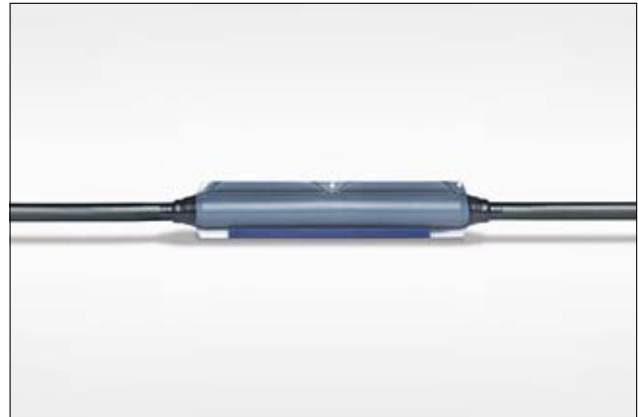

Flexible straight-through joint F-Line.

<b>MATERIAL</b>	Polyurethane resin 44 Flex (PUR44 Flex)
<b>Colour</b>	Black (BK)
<b>Operating Temperature</b>	-25 °C to +120 °C
<b>Storage Temperature</b>	+4 °C to +40 °C
<b>Shelf Life</b>	24 months

**RoHS** ✓

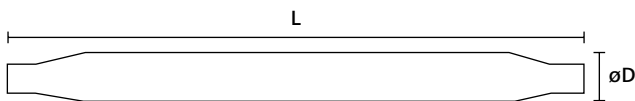

F-Line

**i** Without connector!

TYPE	Ø Main Cable	Main Cable mm <sup>2</sup> min - max		Length (L)	Ø D	Resin Quantity	Article-No.
F-11 / SF	11-16	4 x 1.5	5 x 4	375.0	31.0	250 ml / 300 g	435-00200
F-12 / SF	17-20	4 x 4	5 x 6	375.0	34.0	350 ml / 420 g	435-00201
F-13 / SF	21-27	4 x 10	5 x 16	450.0	42.0	400 ml / 480 g	435-00202
F-14 / SF	25-32	4 x 16	5 x 25	450.0	42.0	600 ml / 720 g	435-00203
F-15 / SF	30-38	4 x 25	5 x 35	440.0	46.0	655 ml / 786 g	435-00204

All dimensions in mm. Subject to technical changes.  
Minimum Order Quantity (MOQ) may differ from package content.

For product specific approvals please contact us under [www.HellermannTyton.com](http://www.HellermannTyton.com)

## Branch joints

### RELICON Y-Line SF

RELICON branch joints are made for installations in low-voltage electrical networks. They are suitable for jointing on polymeric cables and wires made of PVC, XLPE, PE, EPR and utility cables.

Application: Underground, submerged, outdoor, indoor and wiring ducts.

### Features and Benefits

- Two-part, impact-proof, transparent moulding shells
- Compact, optimized dimensions
- Standard cable diameters indicated on the shells
- SF-system
- Immediately ready for use
- Longitudinally and transversely watertight
- Joint can be cast under influence of water

### Content of Set / Kit

- Cast resin PUR 33
- Two-chamber pouch, transparent
- Moulding shells, transparent
- SF-system and nozzle
- Protective gloves, emery cloth, installation instructions
- HelaTape PVC insulating tape

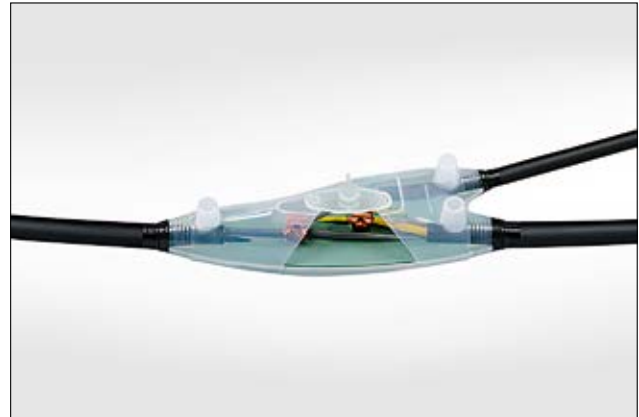

Branch joint Y-Line SF (safe filling).

<b>MATERIAL</b>	Polyurethane resin 33 (PUR33)
<b>Colour</b>	Green (GN)
<b>Operating Temperature</b>	-25 °C to +120 °C
<b>Storage Temperature</b>	+4 °C to +40 °C
<b>Shelf Life</b>	48 months

**RoHS** 

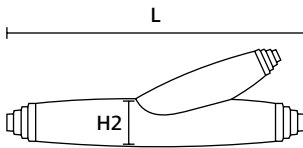

Y-Line

**i** Without branch connector!

TYPE	Ø Main Cable	Main Cable mm <sup>2</sup> min - max		Ø Branch Cable	Angle	Branch Cable mm <sup>2</sup> min - max		Length (L)	Height (H2)	Resin Quantity	Article-No.
Y-1 / SF	8-22	3 x 1.5	5 x 10	10-22	30 °	3 x 1.5	5 x 6	205.0	70.0	490 ml / 671 g	435-12009
Y-0 / SF	10-24	3 x 1.5	4 x 10	10-24	30 °	3 x 1.5	4 x 4	190.0	60.0	240 ml / 329 g	435-12008
Y-3 / SF	10-40	4 x 16	5 x 16	13-28	20 °	4 x 10	5 x 10	330.0	90.0	955 ml / 1308 g	435-12023
Y-2 / SF	25-33	4 x 16	5 x 25	15-30	20 °	4 x 6	5 x 16	350.0	98.0	1445 ml / 1980 g	435-12010
Y-6 / SF	30-55	4 x 95	4 x 185	17-40	20 °	4 x 10	4 x 70	430.0	130.0	2 x 1450 ml / 1987 g	435-12012
Y-5 / SF	35-51	4 x 25	4 x 150	17-33	15 °	4 x 10	4 x 50	298.0	120.0	2045 ml / 2802 g	435-12011

All dimensions in mm. Subject to technical changes.  
Minimum Order Quantity (MOQ) may differ from package content.





### Branch joints

#### RELICON T-Line SF

RELICON branch joints are made for installations in low-voltage electrical networks. They are suitable for jointing on polymeric cables and wires made of PVC, XLPE, PE, EPR and utility cables.

Application: Underground, submerged, outdoor, indoor and wiring ducts.

#### Features and Benefits

- Two-part, impact-proof, transparent moulding shells
- Compact, optimized dimensions
- Standard cable diameters indicated on the shells
- SF-system
- Immediately ready for use
- Longitudinally and transversely watertight
- Joint can be cast under influence of water

#### Content of Set / Kit

- Cast resin PUR 33
- Two-chamber pouch, transparent
- Moulding shells, transparent
- SF-system and nozzle
- Protective gloves, emery cloth, installation instructions
- HelaTape PVC insulating tape



Branch joint T-Line SF (safe filling).

<b>MATERIAL</b>	Polyurethane resin 33 (PUR33)
<b>Colour</b>	Green (GN)
<b>Operating Temperature</b>	-25 °C to +120 °C
<b>Storage Temperature</b>	+4 °C to +40 °C
<b>Shelf Life</b>	48 months

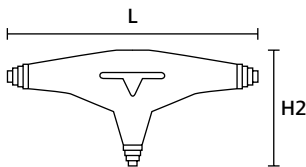

T-Line



**Without branch connector!**

TYPE	Ø Main Cable	Main Cable mm <sup>2</sup> min - max		Ø Branch Cable	Angle	Branch Cable mm <sup>2</sup> min - max		Length (L)	Height (H2)	Resin Quantity	Article-No.
T-1 / SF	16-26	5 x 1.5	5 x 10	10-24	90 °	3 x 1.5	5 x 6	276.0	177.0	455 ml / 623 g	435-12024
T-2 / SF	25-32	5 x 6	5 x 16	18-25	90 °	5 x 1.5	5 x 10	380.0	225.0	2045 ml / 2802 g	435-12025
T-3 / SF	29-40	5 x 10	5 x 50	20-30	90 °	5 x 6	5 x 16	520.0	205.0	2 x 1450 ml / 1987 g	435-12026

All dimensions in mm. Subject to technical changes.  
Minimum Order Quantity (MOQ) may differ from package content.

For product specific approvals please contact us under [www.HellermannTyton.com](http://www.HellermannTyton.com)

## Parallel branch joint house connections

### RELICON PAH-1

The parallel branch joint PAH is a universal straight-through and branch joint. Suitable as single branch joint with commercial branch clamping rings. For polymeric cables and wires made of PVC, XLPE, PE, EPR and utility cables.

Application: In low-voltage electrical networks as branch joint for building connections. Underground, submerged, outdoor, indoor.

#### Features and Benefits

- Impact-proof, transparent moulding shell
- Compact, optimized dimensions
- Longitudinally and transversely watertight
- SF-system
- Joint can be cast under influence of water
- Immediately ready for use
- Suitable for all compact branch clamping rings
- Certified according to DIN EN 50393 (corresponds to DIN VDE 0278-393)

#### Content of Set / Kit

- Cast resin PUR 33, 1900 ml/2603 g
- In a two-chamber pouch or in cans
- Transparent moulding shell
- Foam seal, protective gloves, emery cloth
- Cleaning cloth, cable kit, installation instructions
- SF-nozzle (two-chamber pouch)
- Mixing stick (can)

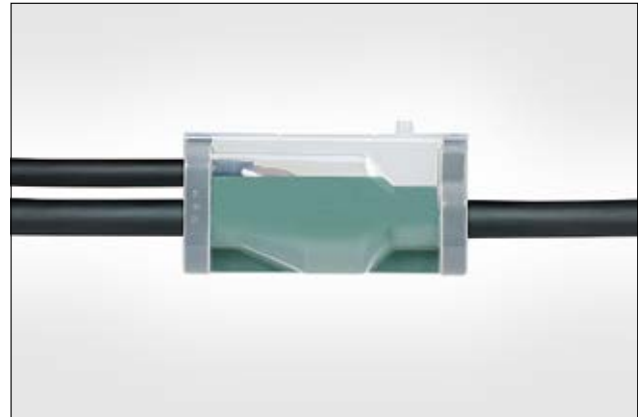

Parallel branch joint PAH-1 120/290, house connector set.

<b>MATERIAL</b>	Polyurethane resin 33 (PUR33)
<b>Colour</b>	Green (GN)
<b>Operating Temperature</b>	-25 °C to +120 °C
<b>Storage Temperature</b>	+4 °C to +40 °C
<b>Shelf Life</b>	48 months

**RoHS** 

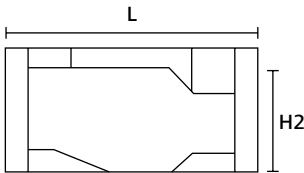

PAH-1

TYPE	Ø Main Cable	Main Cable mm <sup>2</sup>		Ø Branch Cable	Branch Cable mm <sup>2</sup>		Length (L)	Height (H2)	Connector	Pack	Article-No.
		min	max		min	max					
PAH-1-120/290-B-SF	30-50	4 x 16	4 x 150	18-33	4 x 35	4 x 150	290.0	120.0	none	Bag	435-00153
PAH-1-120/290-C-S	30-50	4 x 35	4 x 95	18-33	4 x 16	4 x 50	290.0	120.0	Isicompact-S	Can	435-00167
PAH-1-120/290-B-SF-S	30-50	4 x 35	4 x 95	18-33	4 x 16	4 x 50	290.0	120.0	Isicompact-S	Bag	435-00173
PAH-1-120/290-C	30-50	4 x 35	4 x 150	18-33	4 x 16	4 x 50	290.0	120.0	none	Can	435-00159
PAH-1-120/290-C-M	30-50	4 x 35	4 x 150	18-33	4 x 16	4 x 50	290.0	120.0	Isicompact-M	Can	435-00164
PAH-1-120/290-B-SF-M	30-50	4 x 35	4 x 150	18-33	4 x 16	4 x 50	290.0	120.0	Isicompact-M	Bag	435-00170

All dimensions in mm. Subject to technical changes.  
Minimum Order Quantity (MOQ) may differ from package content.



## Parallel branch joint house connections

### RELICON PAH-2

The parallel branch joint PAH is a universal straight-through and branch joint. Suitable as single branch joint with commercial branch clamping rings. For polymeric cables and wires made of PVC, XLPE, PE, EPR and utility cables.

Application: In low-voltage electrical networks as branch joint for building connections. Underground, submerged, outdoor, indoor.

#### Features and Benefits

- Impact-proof, transparent moulding shell
- Compact, optimized dimensions
- Longitudinally and transversely watertight
- SF-system
- Joint can be cast under influence of water
- Immediately ready for use
- Suitable for all compact branch clamping rings
- Certified according to DIN EN 50393 (corresponds to DIN VDE 0278-393)

#### Content of Set / Kit

- Cast resin Reliflex, 1950 ml/2379 g, non-toxic
- In a two-chamber pouch or in cans
- Transparent moulding shell
- Foam seal, protective gloves, emery cloth
- Cleaning cloth, cable kit, installation instructions
- SF-nozzle (two-chamber pouch)
- Mixing stick (can)

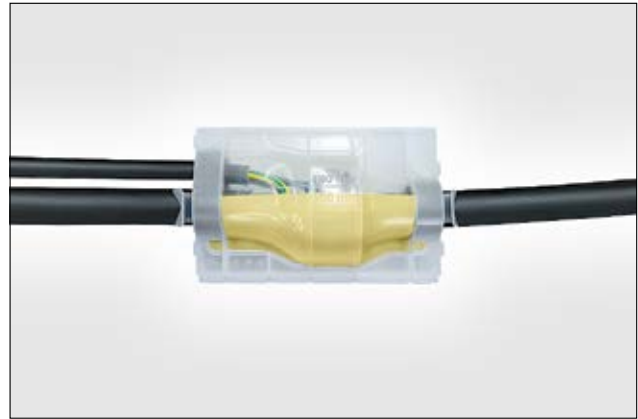

Parallel branch joint PAH-2 130/300, house connector set.

<b>MATERIAL</b>	Cold sealing compound Reliflex (Reliflex)
<b>Colour</b>	Yellow (YE)
<b>Operating Temperature</b>	-40 °C to +90 °C
<b>Storage Temperature</b>	+4 °C to +40 °C
<b>Shelf Life</b>	36 months

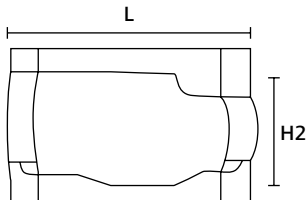

PAH-2

TYPE	Ø Main Cable	Main Cable mm <sup>2</sup> min - max		Ø Branch Cable	Branch Cable mm <sup>2</sup> min - max		Length (L)	Height (H2)	Connector	Pack	Article-No.
PAH-2-130/300-C-S	27-49	4 x 35	4 x 95	15-33	4 x 6	4 x 70	300.0	130.0	Isicompact-S	Can	435-00864
PAH-2-130/300-B-SF-S	27-49	4 x 35	4 x 95	15-33	4 x 6	4 x 70	300.0	130.0	Isicompact-S	Bag	435-00868
PAH-2-130/300-B-SF	27-49	4 x 35	4 x 150	15-33	4 x 6	4 x 70	300.0	130.0	none	Bag	435-00855
PAH-2-130/300-C	27-49	4 x 35	4 x 150	15-33	4 x 6	4 x 70	300.0	130.0	none	Can	435-00858
PAH-2-130/300-C-M	27-49	4 x 35	4 x 150	15-33	4 x 6	4 x 70	300.0	130.0	Isicompact-M	Can	435-00862
PAH-2-130/300-B-SF-M	27-49	4 x 35	4 x 150	15-33	4 x 6	4 x 70	300.0	130.0	Isicompact-M	Bag	435-00866

All dimensions in mm. Subject to technical changes.  
Minimum Order Quantity (MOQ) may differ from package content.

For product specific approvals please contact us under [www.HellermannTyton.com](http://www.HellermannTyton.com)



## Parallel branch joint house connections

### RELICON PAH-2

The parallel branch joint PAH is a universal straight-through and branch joint. Suitable as single branch joint with commercial branch clamping rings. For polymeric cables and wires made of PVC, XLPE, PE, EPR and utility cables.

Application: In low-voltage electrical networks as branch joint for building connections. Underground, submerged, outdoor, indoor.

#### Features and Benefits

- Impact-proof, transparent moulding shell
- Compact, optimized dimensions
- Longitudinally and transversely watertight
- SF-system
- Joint can be cast under influence of water
- Immediately ready for use
- Suitable for all compact branch clamping rings
- Certified according to DIN EN 50393 (corresponds to DIN VDE 0278-393)

#### Content of Set / Kit

- Cast resin PUR 33, 1950 ml/2672 g
- In a two-chamber pouch or in cans
- Transparent moulding shell
- Foam seal, protective gloves, emery cloth
- Cleaning cloth, cable kit, installation instructions
- SF-nozzle (two-chamber pouch)
- Mixing stick (can)



Parallel branch joint PAH-2 130/300, house connector set.

<b>MATERIAL</b>	Polyurethane resin 33 (PUR33)
<b>Colour</b>	Green (GN)
<b>Operating Temperature</b>	-25 °C to +120 °C
<b>Storage Temperature</b>	+4 °C to +40 °C
<b>Shelf Life</b>	48 months

**RoHS** 

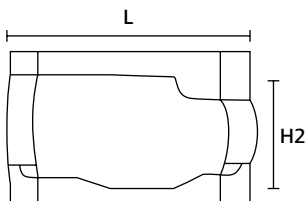

PAH-2

TYPE	Ø Main Cable	Main Cable mm <sup>2</sup> min - max		Ø Branch Cable	Branch Cable mm <sup>2</sup> min - max		Length (L)	Height (H2)	Connector	Pack	Article-No.
PAH-2-130/300-C-S	27-49	4 x 35	4 x 95	15-33	4 x 6	4 x 70	300.0	130.0	Isicompact-S	Can	435-00168
PAH-2-130/300-B-SF-S	27-49	4 x 35	4 x 95	15-33	4 x 6	4 x 70	300.0	130.0	Isicompact-S	Bag	435-00174
PAH-2-130/300-B-SF	27-49	4 x 35	4 x 150	15-33	4 x 6	4 x 70	300.0	130.0	none	Bag	435-00154
PAH-2-130/300-C	27-49	4 x 35	4 x 150	15-33	4 x 6	4 x 70	300.0	130.0	none	Can	435-00160
PAH-2-130/300-C-M	27-49	4 x 35	4 x 150	15-33	4 x 6	4 x 70	300.0	130.0	Isicompact-M	Can	435-00165
PAH-2-130/300-B-SF-M	27-49	4 x 35	4 x 150	15-33	4 x 6	4 x 70	300.0	130.0	Isicompact-M	Bag	435-00171

All dimensions in mm. Subject to technical changes.  
Minimum Order Quantity (MOQ) may differ from package content.



### Parallel branch joint house connections

#### RELICON PAH-3

The parallel branch joint PAH is a universal straight-through and branch joint. Suitable as single branch joint with commercial branch clamping rings. For polymeric cables and wires made of PVC, XLPE, PE, EPR and utility cables.

Application: In low-voltage electrical networks as branch joint for building connections. Underground, submerged, outdoor, indoor.

#### Features and Benefits

- Impact-proof, transparent moulding shell
- Compact, optimized dimensions
- Longitudinally and transversely watertight
- SF-system
- Joint can be cast under influence of water
- Immediately ready for use
- Suitable for all compact branch clamping rings

#### Content of Set / Kit

- Cast resin Reliflex, 2800 ml/3416 g, non-toxic
- In a two-chamber pouch or in cans
- Transparent moulding shell
- Foam seal, protective gloves, emery cloth
- Cleaning cloth, cable kit, installation instructions
- SF-nozzle (two-chamber pouch)
- Mixing stick (can)

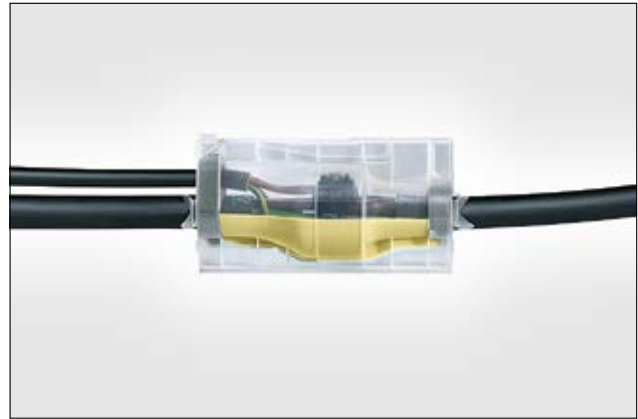

Parallel branch joint PAH-3 135/360, house connector set.

<b>MATERIAL</b>	Cold sealing compound Reliflex (Reliflex)
<b>Colour</b>	Yellow (YE)
<b>Operating Temperature</b>	-40 °C to +90 °C
<b>Storage Temperature</b>	+4 °C to +40 °C
<b>Shelf Life</b>	36 months

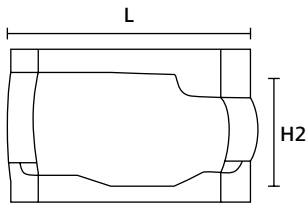

PAH-3

TYPE	Ø Main Cable	Main Cable mm <sup>2</sup> min - max		Ø Branch Cable	Branch Cable mm <sup>2</sup> min - max		Length (L)	Height (H2)	Connector	Pack	Article-No.
PAH-3-135/360-B-SF	27-49	4 x 35	4 x 95	15-33	4 x 6	4 x 70	360.0	135.0	none	Bag	435-00856
PAH-3-135/360-C-S	27-49	4 x 35	4 x 95	15-33	4 x 6	4 x 70	360.0	135.0	Isicompact-S	Can	435-00865
PAH-3-135/360-B-SF-S	27-49	4 x 35	4 x 95	15-33	4 x 6	4 x 70	360.0	135.0	Isicompact-S	Bag	435-00869
PAH-3-135/360-C	27-49	4 x 35	4 x 185	15-33	4 x 6	4 x 70	360.0	135.0	none	Can	435-00859
PAH-3-135/360-C-M	27-49	4 x 35	4 x 185	15-33	4 x 6	4 x 70	360.0	135.0	Isicompact-M	Can	435-00863
PAH-3-135/360-B-SF-M	27-49	4 x 35	4 x 185	15-33	4 x 6	4 x 70	360.0	135.0	Isicompact-M	Bag	435-00867

All dimensions in mm. Subject to technical changes.  
Minimum Order Quantity (MOQ) may differ from package content.

For product specific approvals please contact us under [www.HellermannTyton.com](http://www.HellermannTyton.com)

## Parallel branch joint house connections

### RELICON PAH-3

The parallel branch joint PAH is a universal straight-through and branch joint. Suitable as single branch joint with commercial branch clamping rings. For polymeric cables and wires made of PVC, XLPE, PE, EPR and utility cables.

Application: In low-voltage electrical networks as branch joint for building connections. Underground, submerged, outdoor, indoor.

#### Features and Benefits

- Impact-proof, transparent moulding shell
- Compact, optimized dimensions
- Longitudinally and transversely watertight
- SF-system
- Joint can be cast under influence of water
- Immediately ready for use
- Suitable for all compact branch clamping rings

#### Content of Set / Kit

- Cast resin PUR 33, 2800 ml/3836 g
- In a two-chamber pouch or in cans
- Transparent moulding shell
- Foam seal, protective gloves, emery cloth
- Cleaning cloth, cable kit, installation instructions
- SF-nozzle (two-chamber pouch)
- Mixing stick (can)

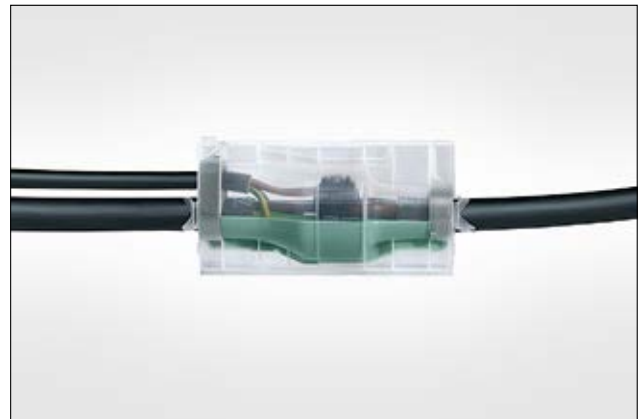

Parallel branch joint PAH-3 135/360, house connector set.

<b>MATERIAL</b>	Polyurethane resin 33 (PUR33)
<b>Colour</b>	Green (GN)
<b>Operating Temperature</b>	-25 °C to +120 °C
<b>Storage Temperature</b>	+4 °C to +40 °C
<b>Shelf Life</b>	48 months

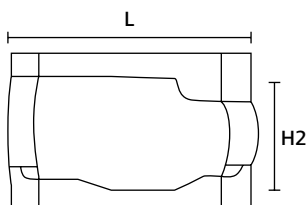

PAH-3

TYPE	Ø Main Cable	Main Cable mm <sup>2</sup> min - max		Ø Branch Cable	Branch Cable mm <sup>2</sup> min - max		Length (L)	Height (H2)	Connector	Pack	Article-No.
PAH-3-135/360-C-S	27-49	4 x 35	4 x 70	15-33	4 x 6	4 x 95	360.0	135.0	Isicompact-S	Can	435-00169
PAH-3-135/360-B-SF-S	27-49	4 x 35	4 x 95	15-33	4 x 6	4 x 70	360.0	135.0	Isicompact-S	Bag	435-00175
PAH-3-135/360-B-SF	27-49	4 x 35	4 x 185	15-33	4 x 6	4 x 70	360.0	135.0	none	Bag	435-00155
PAH-3-135/360-C	27-49	4 x 35	4 x 185	15-33	4 x 6	4 x 70	360.0	135.0	none	Can	435-00161
PAH-3-135/360-C-M	27-49	4 x 35	4 x 185	15-33	4 x 6	4 x 70	360.0	135.0	Isicompact-M	Can	435-00166
PAH-3-135/360-B-SF-M	27-49	4 x 35	4 x 185	15-33	4 x 6	4 x 70	360.0	135.0	Isicompact-M	Bag	435-00172

All dimensions in mm. Subject to technical changes.  
Minimum Order Quantity (MOQ) may differ from package content.





### Parallel branch joint house connections

#### RELICON PAH-4

The parallel branch joint PAH is a universal straight-through and branch joint. Suitable as single branch joint with commercial branch clamping rings. For polymeric cables and wires made of PVC, XLPE, PE, EPR and utility cables.

Application: In low-voltage electrical networks as branch joint for building connections. Underground, submerged, outdoor, indoor.

#### Features and Benefits

- Impact-proof, transparent moulding shell
- Compact, optimized dimensions
- Longitudinally and transversely watertight
- SF-system
- Joint can be cast under influence of water
- Immediately ready for use
- Suitable for all compact branch clamping rings

#### Content of Set / Kit

- Cast resin Reliflex, 3900 ml/4758 g, non-toxic
- In a two-chamber pouch or in cans
- Transparent moulding shell
- Foam seal, protective gloves, emery cloth
- Cleaning cloth, cable kit, installation instructions
- SF-nozzle (two-chamber pouch)
- Mixing stick (can)

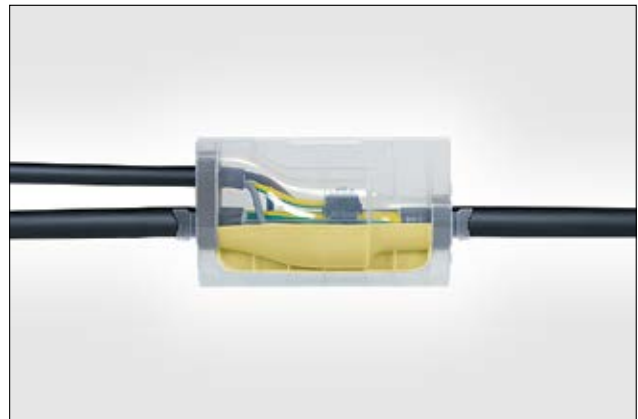

Parallel branch joint PAH-4 140/420, house connector set.

<b>MATERIAL</b>	Cold sealing compound Reliflex (Reliflex)
<b>Colour</b>	Yellow (YE)
<b>Operating Temperature</b>	-40 °C to +90 °C
<b>Storage Temperature</b>	+4 °C to +40 °C
<b>Shelf Life</b>	36 months

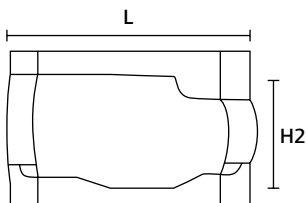

PAH-4

**i Without branch connector!**

TYPE	Ø Main Cable	Main Cable mm <sup>2</sup> min - max		Ø Branch Cable	Branch Cable mm <sup>2</sup> min - max		Length (L)	Height (H2)	Connector	Pack	Article-No.
PAH-4-140/420-B-SF	27-58	4 x 70	4 x 240	15-49	4 x 70	4 x 240	420.0	140.0	none	Bag	435-00857
PAH-4-140/420-C	27-58	4 x 70	4 x 240	15-49	4 x 70	4 x 240	420.0	140.0	none	Can	435-00860

All dimensions in mm. Subject to technical changes.  
Minimum Order Quantity (MOQ) may differ from package content.

## Parallel branch joint house connections

### RELICON PAH-4

The parallel branch joint PAH is a universal straight-through and branch joint. Suitable as single branch joint with commercial branch clamping rings. For polymeric cables and wires made of PVC, XLPE, PE, EPR and utility cables.

Application: In low-voltage electrical networks as branch joint for building connections. Underground, submerged, outdoor, indoor.

#### Features and Benefits

- Impact-proof, transparent moulding shell
- Compact, optimized dimensions
- Longitudinally and transversely watertight
- SF-system
- Joint can be cast under influence of water
- Immediately ready for use
- Suitable for all compact branch clamping rings

#### Content of Set / Kit

- Cast resin PUR 33, 3900 ml/5343 g
- In a two-chamber pouch or in cans
- Transparent moulding shell
- Foam seal, protective gloves, emery cloth
- Cleaning cloth, cable kit, installation instructions
- SF-nozzle (two-chamber pouch)
- Mixing stick (can)

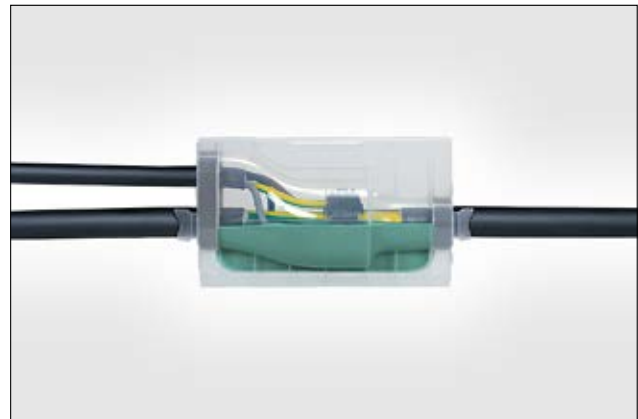

Parallel branch joint PAH-4 140/420, house connector set.

<b>MATERIAL</b>	Polyurethane resin 33 (PUR33)
<b>Colour</b>	Green (GN)
<b>Operating Temperature</b>	-25 °C to +120 °C
<b>Storage Temperature</b>	+4 °C to +40 °C
<b>Shelf Life</b>	48 months

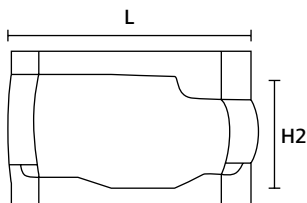

PAH-4

**i** Without branch connector!

TYPE	Ø Main Cable	Main Cable mm <sup>2</sup> min - max		Ø Branch Cable	Branch Cable mm <sup>2</sup> min - max		Length (L)	Height (H2)	Connector	Pack	Article-No.
PAH-4-140/420-B-SF	27-58	4 x 70	4 x 240	15-49	4 x 70	4 x 240	420.0	140.0	none	Bag	435-00156
PAH-4-140/420-C	27-58	4 x 70	4 x 240	15-49	4 x 70	4 x 240	420.0	140.0	none	Can	435-00162

All dimensions in mm. Subject to technical changes.  
Minimum Order Quantity (MOQ) may differ from package content.



### Parallel branch joint

#### RELICON PA-11

The parallel branch joint PA is a universal straight-through and branch joint. Depending on the connector, it can be used for single and double branches. They are suitable for jointing on polymeric cables and wires made of PVC, XLPE, PE, EPR and utility cables.

Application: In low-voltage electrical networks as well as for signal and communication cables. For power supply lines for outdoor lighting and for cable repairs. Underground, submerged, outdoor, indoor and wiring ducts.

#### Features and Benefits

- One-piece, impact-proof, transparent moulding shell
- Captive lids
- Compact, optimized dimensions
- Longitudinally and transversely watertight
- Joint can be cast under influence of water
- Immediately ready for use

#### Content of Set / Kit

- Cast resin Reliflex, non-toxic
- In a two-chamber pouch or in cans
- Transparent, one-piece moulding shell
- Foam seal, protective gloves, emery cloth
- Cleaning cloth, installation instructions
- SF-nozzle (two-chamber pouch)
- Mixing stick (can)

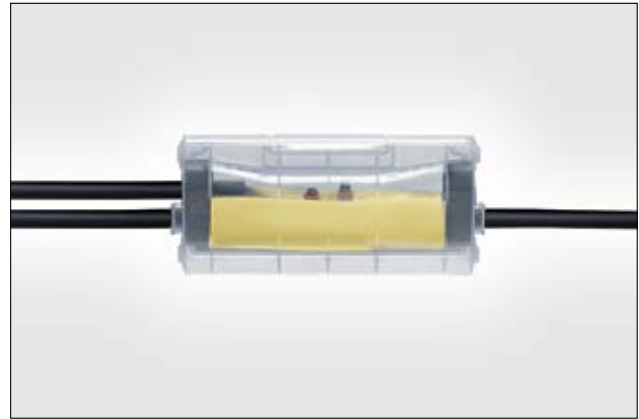

Parallel branch joint PA-11 58/230.

<b>MATERIAL</b>	Cold sealing compound Reliflex (Reliflex)
<b>Colour</b>	Yellow (YE)
<b>Operating Temperature</b>	-40 °C to +90 °C
<b>Storage Temperature</b>	+4 °C to +40 °C
<b>Shelf Life</b>	36 months

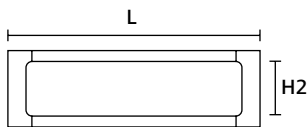

PA-11

**i Without branch connector!**

TYPE	Ø Main Cable	Main Cable mm <sup>2</sup> min - max		Ø Branch Cable	Branch Cable mm <sup>2</sup> min - max		Length (L)	Height (H2)	Resin Quantity	Pack	Article-No.
PA-11-58/230-B-SF	13-21	4 x 1.5	5 x 10	13-21	4 x 1.5	5 x 10	230.0	58.0	490 ml / 598 g	Bag	435-00850
PA-11-58/230-C	13-21	4 x 1.5	5 x 10	13-21	4 x 1.5	5 x 10	230.0	58.0	490 ml / 598 g	Can	435-00853

All dimensions in mm. Subject to technical changes.  
Minimum Order Quantity (MOQ) may differ from package content.

## Parallel branch joint

### RELICON PA-11

The parallel branch joint PA is a universal straight-through and branch joint. Depending on the connector, it can be used for single and double branches. They are suitable for jointing on polymeric cables and wires made of PVC, XLPE, PE, EPR and utility cables.

Application: In low-voltage electrical networks as well as for signal and communication cables. For power supply lines for outdoor lighting and for cable repairs. Underground, submerged, outdoor, indoor and wiring ducts.

### Features and Benefits

- One-piece, impact-proof, transparent moulding shell
- Captive lids
- Compact, optimized dimensions
- Longitudinally and transversely watertight
- Joint can be cast under influence of water
- Immediately ready for use

### Content of Set / Kit

- Cast resin PUR 33
- In a two-chamber pouch or in cans
- Transparent, one-piece moulding shell
- Foam seal, protective gloves, emery cloth
- Cleaning cloth, installation instructions
- SF-nozzle (two-chamber pouch)
- Mixing stick (can)



Parallel branch joint PA-11 58/230.

<b>MATERIAL</b>	Polyurethane resin 33 (PUR33)
<b>Colour</b>	Green (GN)
<b>Operating Temperature</b>	-25 °C to +120 °C
<b>Storage Temperature</b>	+4 °C to +40 °C
<b>Shelf Life</b>	48 months

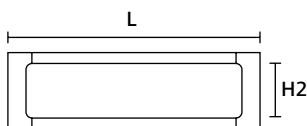

PA-11

**i** Without branch connector!

TYPE	Ø Main Cable	Main Cable mm <sup>2</sup> min - max	Ø Branch Cable	Branch Cable mm <sup>2</sup> min - max	Length (L)	Height (H2)	Resin Quantity	Pack	Article-No.
PA-11-58/230-B-SF	13-21	4 x 1.5 5 x 10	13-21	4 x 1.5 5 x 10	230.0	58.0	490 ml / 671 g	Bag	435-00150
PA-11-58/230-C	13-21	4 x 1.5 5 x 10	13-21	4 x 1.5 5 x 10	230.0	58.0	490 ml / 671 g	Can	435-00157

All dimensions in mm. Subject to technical changes.  
Minimum Order Quantity (MOQ) may differ from package content.



### Parallel branch joint

#### RELICON PA-12

The parallel branch joint PA is a universal straight-through and branch joint. Depending on the connector, it can be used for single and double branches. They are suitable for jointing on polymeric cables and wires made of PVC, XLPE, PE, EPR and utility cables.

Application: In low-voltage electrical networks as well as for signal and communication cables. For power supply lines for outdoor lighting and for cable repairs. Underground, submerged, outdoor, indoor and wiring ducts.

#### Features and Benefits

- One-piece, impact-proof, transparent moulding shell
- Captive lids
- Compact, optimized dimensions
- Longitudinally and transversely watertight
- Joint can be cast under influence of water
- Immediately ready for use

#### Content of Set / Kit

- Cast resin Reliflex, non-toxic
- In a two-chamber pouch or in cans
- Transparent, one-piece moulding shell
- Foam seal, protective gloves, emery cloth
- Cleaning cloth, installation instructions
- SF-nozzle (two-chamber pouch)
- Mixing stick (can)



Parallel branch joint PA-12 75/300.

<b>MATERIAL</b>	Cold sealing compound Reliflex (Reliflex)
<b>Colour</b>	Yellow (YE)
<b>Operating Temperature</b>	-40 °C to +90 °C
<b>Storage Temperature</b>	+4 °C to +40 °C
<b>Shelf Life</b>	36 months

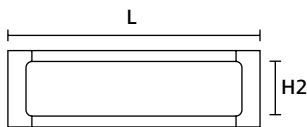

PA-12

**i Without branch connector!**

TYPE	Ø Main Cable	Main Cable mm <sup>2</sup> min - max		Ø Branch Cable	Branch Cable mm <sup>2</sup> min - max		Length (L)	Height (H2)	Resin Quantity	Pack	Article-No.
PA-12-75/300-B-SF	17-29	4 x 16	5 x 25	13-22	4 x 6	5 x 16	300.0	75.0	955 ml / 1165 g	Bag	435-00851
PA-12-75/300-C	17-29	4 x 16	5 x 25	13-22	4 x 6	5 x 16	300.0	75.0	955 ml / 1165 g	Can	435-00854

All dimensions in mm. Subject to technical changes.  
Minimum Order Quantity (MOQ) may differ from package content.



## Parallel branch joint

### RELICON PA-12

The parallel branch joint PA is a universal straight-through and branch joint. Depending on the connector, it can be used for single and double branches. They are suitable for jointing on polymeric cables and wires made of PVC, XLPE, PE, EPR and utility cables.

Application: In low-voltage electrical networks as well as for signal and communication cables. For power supply lines for outdoor lighting and for cable repairs. Underground, submerged, outdoor, indoor and wiring ducts.

### Features and Benefits

- One-piece, impact-proof, transparent moulding shell
- Captive lids
- Compact, optimized dimensions
- Longitudinally and transversely watertight
- Joint can be cast under influence of water
- Immediately ready for use

### Content of Set / Kit

- Cast resin PUR 33
- In a two-chamber pouch or in cans
- Transparent, one-piece moulding shell
- Foam seal, protective gloves, emery cloth
- Cleaning cloth, installation instructions
- SF-nozzle (two-chamber pouch)
- Mixing stick (can)



Parallel branch joint PA-12 75/300.

<b>MATERIAL</b>	Polyurethane resin 33 (PUR33)
<b>Colour</b>	Green (GN)
<b>Operating Temperature</b>	-25 °C to +120 °C
<b>Storage Temperature</b>	+4 °C to +40 °C
<b>Shelf Life</b>	48 months

**RoHS** 

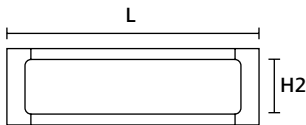

PA-12

**i** Without branch connector!

TYPE	Ø Main Cable	Main Cable mm <sup>2</sup> min - max		Ø Branch Cable	Branch Cable mm <sup>2</sup> min - max		Length (L)	Height (H2)	Resin Quantity	Pack	Article-No.
PA-12-75/300-B-SF	17-29	4 x 16	5 x 25	13-22	4 x 6	5 x 16	300.0	75.0	955 ml / 1308 g	Bag	435-00151
PA-12-75/300-C	17-29	4 x 16	5 x 25	13-22	4 x 6	5 x 16	300.0	75.0	955 ml / 1308 g	Can	435-00158

All dimensions in mm. Subject to technical changes.  
Minimum Order Quantity (MOQ) may differ from package content.



### Parallel branch joint

#### RELICON PA-13

The parallel branch joint PA is a universal straight-through and branch joint. Depending on the connector, it can be used for single and double branches. They are suitable for jointing on polymeric cables and wires made of PVC, XLPE, PE, EPR and utility cables.

Application: In low-voltage electrical networks as well as for signal and communication cables. For power supply lines for outdoor lighting and for cable repairs. Underground, submerged, outdoor, indoor and wiring ducts.

#### Features and Benefits

- One-piece, impact-proof, transparent moulding shell
- Captive lids
- Compact, optimized dimensions
- Longitudinally and transversely watertight
- Joint can be cast under influence of water
- Immediately ready for use

#### Content of Set / Kit

- Cast resin Reliflex, non-toxic
- In a two-chamber pouch or in cans
- Transparent, one-piece moulding shell
- Foam seal, protective gloves, emery cloth
- Cleaning cloth, installation instructions
- SF-nozzle (two-chamber pouch)
- Mixing stick (can)



Parallel branch joint PA-13 95/420.

<b>MATERIAL</b>	Cold sealing compound Reliflex (Reliflex)
<b>Colour</b>	Yellow (YE)
<b>Operating Temperature</b>	-40 °C to +90 °C
<b>Storage Temperature</b>	+4 °C to +40 °C
<b>Shelf Life</b>	36 months

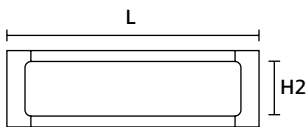

PA-13

**i Without branch connector!**

TYPE	Ø Main Cable	Main Cable mm <sup>2</sup> min - max		Ø Branch Cable	Branch Cable mm <sup>2</sup> min - max		Length (L)	Height (H2)	Resin Quantity	Pack	Article-No.
PA-13-95/420-B-SF	27-35	4 x 10	5 x 35	21-30	4 x 25	5 x 35	420.0	95.0	2240 ml / 2733 g	Bag	435-00852
PA-13-95/420-C	27-35	4 x 10	5 x 35	21-30	4 x 25	5 x 35	420.0	95.0	2240 ml / 2733 g	Can	435-00861

All dimensions in mm. Subject to technical changes.  
Minimum Order Quantity (MOQ) may differ from package content.

## Parallel branch joint

### RELICON PA-13

The parallel branch joint PA is a universal straight-through and branch joint. Depending on the connector, it can be used for single and double branches. They are suitable for jointing on polymeric cables and wires made of PVC, XLPE, PE, EPR and utility cables.

Application: In low-voltage electrical networks as well as for signal and communication cables. For power supply lines for outdoor lighting and for cable repairs. Underground, submerged, outdoor, indoor and wiring ducts.

### Features and Benefits

- One-piece, impact-proof, transparent moulding shell
- Captive lids
- Compact, optimized dimensions
- Longitudinally and transversely watertight
- Joint can be cast under influence of water
- Immediately ready for use

### Content of Set / Kit

- Cast resin PUR 33
- In a two-chamber pouch or in cans
- Transparent, one-piece moulding shell
- Foam seal, protective gloves, emery cloth
- Cleaning cloth, installation instructions
- SF-nozzle (two-chamber pouch)
- Mixing stick (can)



Parallel branch joint PA-13 95/420.

<b>MATERIAL</b>	Polyurethane resin 33 (PUR33)
<b>Colour</b>	Green (GN)
<b>Operating Temperature</b>	-25 °C to +120 °C
<b>Storage Temperature</b>	+4 °C to +40 °C
<b>Shelf Life</b>	48 months

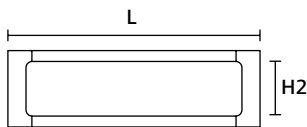

PA-13

**i** Without branch connector!

TYPE	Ø Main Cable	Main Cable mm <sup>2</sup> min - max		Ø Branch Cable	Branch Cable mm <sup>2</sup> min - max		Length (L)	Height (H2)	Resin Quantity	Pack	Article-No.
PA-13-95/420-B-SF	27-35	4 x 10	5 x 35	21-30	4 x 25	5 x 35	420.0	95.0	2240 ml / 3069 g	Bag	435-00152
PA-13-95/420-C	27-35	4 x 10	5 x 35	21-30	4 x 25	5 x 35	420.0	95.0	2240 ml / 3069 g	Can	435-00163

All dimensions in mm. Subject to technical changes.  
Minimum Order Quantity (MOQ) may differ from package content.

# RELICON expertise for cast resins and gels: Choose the right product for your application.

PRODUCT FAMILY	Pot Life	Shore Hardness A	Shore Hardness D	Operating Temperature	Dielectric Strength	Shelf Life	Exothermicity max.	Removable	
<b>Two-component polyurethane cast resin</b>									
RELICON PUR 33	43 min. 5 °C, 15 min. 23 °C, 8 min. 40 °C	–	65±5	-25 °C to +120 °C	38 kV/mm	48 months	+71 °C	–	
RELICON PUR 66	43 min. 5 °C, 15 min. 23 °C, 8 min. 40 °C	–	68±5	-25 °C to +120 °C	38 kV/mm	48 months	+71 °C	–	
RELICON PUR 661 LP	130 min. 5 °C, 40 min. 23 °C, 20 min. 40 °C	–	56±5	-25 °C to +120 °C	>20 kV/mm	48 months	+58 °C	–	
RELICON PUR 771	50 min. 5 °C, 15 min. 23 °C, 5 min. 40 °C	–	56±5	-25 °C to +130 °C	>20 kV/mm	36 months	+71 °C	–	
RELICON PUR 44 Flex	35 min. 5 °C, 15 min. 23 °C, 6 min. 40 °C	60±5	–	-25 °C to +120 °C	20 kV/mm	24 months	+80 °C	–	
RELICON PUR 112 FR	50 min. 5 °C, 15 min. 23 °C, 5 min. 40 °C	–	80±5	-25 °C to +130 °C	>20 kV/mm	36 months	+71 °C	–	
<b>Two-component cold casting compound</b>									
RELICON Reliflex	40 min. 5 °C, 20 min. 23 °C, 10 min. 40 °C	20±5	–	-40 °C to +90 °C	>10 kV/mm	36 months	–	Yes	
<b>Two-component epoxy resin</b>									
RELICON EP 64	32 min. 5 °C, 13 min. 23 °C, 8 min. 35 °C	–	80±5	-20 °C to +140 °C	>20 kV/mm	48 months	+140 °C	–	
RELICON EP 20	8 min. 40 °C, 18 min. 23 °C, 35 min. 5 °C	–	70±5	-20 °C to +140 °C	>20 kV/mm	48 months	+100 °C	–	
<b>Two-component gel</b>									
RELICON KH 100	40 min. 23 °C	–	–	-40 °C to +90 °C	>20 kV/mm	18 months	–	Yes	
RELICON KH 67	40 min. 23 °C	–	–	-40 °C to +90 °C	>15 kV/mm	36 months	–	Yes	
<b>Two-component silicone gel</b>									
RELICON Religel	10 min. 23 °C	–	–	-40 °C to +140 °C	>20 kV/mm	Unlimited	–	Yes	



# RELICON by HellermannTyton



	Flexible	Vibrations absorbing	Colour	Viscosity
	–	–	Green (GN)	4500 mPa*s, 5 °C (EN ISO 2555), 3000 mPa*s, 23 °C (EN ISO 2555)
	–	–	Black (BK)	4500 mPa*s, 5 °C (EN ISO 2555), 3000 mPa*s, 23 °C (EN ISO 2555)
	–	–	Black (BK)	4000 mPa*s, 5 °C (EN ISO 2555), 2000 mPa*s, 23 °C (EN ISO 2555)
	–	–	Black (BK)	4000 mPa*s, 5 °C (EN ISO 2555), 2000 mPa*s, 23 °C (EN ISO 2555)
	Yes	Yes	Black (BK)	2500 mPa*s, 23 °C (EN ISO 2555)
	–	–	Beige (BGE)	1500 mPa*s, 23 °C (EN ISO 2555), 3000 mPa*s, 5 °C (EN ISO 2555)
	–	Yes	Yellow (YE)	5000 mPa*s, 5 °C (EN ISO 2555), 3300 mPa*s, 23 °C (EN ISO 2555)
	–	–	Black (BK)	3700 mPa*s, 23 °C (EN ISO 2555)
	–	–	Yellow (YE)	2000 mPa*s, 23 °C (EN ISO 2555)
	Yes	Yes	Transparent (CL)	2000 mPa*s, 5 °C (EN ISO 2555), 1500 mPa*s, 23 °C (EN ISO 2555)
	Yes	Yes	Transparent (CL), Yellow (YE)	3000 mPa*s, 5 °C (EN ISO 2555), 2000 mPa*s, 23 °C (EN ISO 2555)
	Yes	Yes	Transparent (CL), Green (GN)	1000 mPa*s, 23 °C (EN ISO 2555), 1500 mPa*s, 5 °C (EN ISO 2555)





### Two-component polyurethane cast resin

#### RELICON PUR 33

The RELICON PUR 33 cast resin has been created for the electrical insulation and mechanical protection of cable connections in low-voltage electrical networks. Also suitable as mechanical and moisture protection on medium-voltage cable connections.

Application: For indoor and outdoor use.

#### Features and Benefits

- In a practical, transparent two-chamber pouch
- Colour changes from blue to green whilst mixing
- Safe-Filling system (SF)
- Excellent flow properties, low volume shrinkage
- Cold curing and very hydrophobic, to cast under the influence of water
- High hydrolytic stability and good curing at low temperatures
- UV, ageing and weather resistant
- Outstanding impact strength and resistance to moisture and atmospheric corrosion
- Excellent adhesion to polymeric cables and wires made of PVC, XLPE, PE, EPR
- SVHC-free, contains no hazardous substances, the cured product can be disposed of with house hold waste
- Halogen free



Two-component polyurethane cast resin PUR 33.

<b>MATERIAL</b>	Polyurethane resin 33 (PUR33)
<b>Colour</b>	Green (GN)
<b>Operating Temperature</b>	-25 °C to +120 °C
<b>Mixing Ratio (weight)</b>	100:26
<b>Exothermicity max.</b>	+71 °C
<b>Gel Time</b>	48 min. 5 °C, 20 min. 23 °C, 9 min. 40 °C
<b>Pot Life</b>	43 min. 5 °C, 15 min. 23 °C, 8 min. 40 °C
<b>Dielectric Strength</b>	38 kV/mm
<b>Viscosity</b>	4500 mPa*s, 5 °C (EN ISO 2555), 3000 mPa*s, 23 °C (EN ISO 2555)
<b>Impact Strength</b>	26 kJ/m <sup>2</sup>
<b>Shore Hardness D</b>	65±5
<b>Storage Temperature</b>	+4 °C to +40 °C
<b>Shelf Life</b>	48 months



TYPE	Resin Quantity	Article-No.
Resin-33-B-SF	95 ml / 130 g	435-00250
	240 ml / 329 g	435-00251
	490 ml / 671 g	435-00252
	655 ml / 897 g	435-00253
	955 ml / 1308 g	435-00254
	1140 ml / 1562 g	435-00255
	1445 ml / 1980 g	435-00256
	1640 ml / 2247 g	435-00257
	1950 ml / 2672 g	435-00258
	2045 ml / 2802 g	435-00259

All dimensions in mm. Subject to technical changes.  
Minimum Order Quantity (MOQ) may differ from package content.

For product specific approvals please contact us under [www.HellermannTyton.com](http://www.HellermannTyton.com)

### Two-component polyurethane cast resin

#### RELICON PUR 66

The RELICON PUR 66 cast resin has been created for the electrical insulation and mechanical protection of cable connections in medium-voltage electrical networks.

Application: For indoor and outdoor use.

#### Features and Benefits

- In a practical, transparent two-chamber pouch
- Safe-Filling system (SF)
- Excellent flow properties, low volume shrinkage
- Cold curing and very hydrophobic, to cast under the influence of water
- High hydrolytic stability and good curing at low temperatures
- UV, ageing and weather resistant
- Outstanding impact strength and resistance to moisture and atmospheric corrosion
- Excellent adhesion to polymeric cables and wires made of PVC, XLPE, PE, EPR
- SVHC-free, contains no hazardous substances, the cured product can be disposed of with house hold waste
- Halogen free



Two-component polyurethane cast resin PUR 66.

<b>MATERIAL</b>	Polyurethane resin 66 (PUR66)
<b>Colour</b>	Black (BK)
<b>Operating Temperature</b>	-25 °C to +120 °C
<b>Mixing Ratio (weight)</b>	100:26
<b>Exothermicity max.</b>	+71 °C
<b>Gel Time</b>	48 min. 5 °C, 9 min. 40 °C
<b>Pot Life</b>	43 min. 5 °C, 15 min. 23 °C, 8 min. 40 °C
<b>Dielectric Strength</b>	38 kV/mm
<b>Viscosity</b>	4500 mPa*s, 5 °C (EN ISO 2555), 3000 mPa*s, 23 °C (EN ISO 2555)
<b>Impact Strength</b>	26 kJ/m <sup>2</sup>
<b>Shore Hardness D</b>	68±5
<b>Storage Temperature</b>	+4 °C to +40 °C
<b>Shelf Life</b>	48 months

HF ✓

RoHS ✓

TYPE	Resin Quantity	Article-No.
Resin-66-B-SF	95 ml / 130 g	435-00300
	165 ml / 226 g	435-00301
	220 ml / 301 g	435-00302
	240 ml / 329 g	435-00303
	400 ml / 548 g	435-00304
	455 ml / 623 g	435-00305
	490 ml / 671 g	435-00306
	655 ml / 897 g	435-00307
	955 ml / 1308 g	435-00308
	1140 ml / 1562 g	435-00309
	1445 ml / 1980 g	435-00310
	1640 ml / 2247 g	435-00311
	1950 ml / 2672 g	435-00312
2045 ml / 2802 g	435-00313	

All dimensions in mm. Subject to technical changes.  
Minimum Order Quantity (MOQ) may differ from package content.

For product specific approvals please contact us under [www.HellermannTyton.com](http://www.HellermannTyton.com)



### Two-component polyurethane cast resin

#### RELICON PUR 771

The RELICON PUR 771 cast resin has been created for the electrical insulation and mechanical protection of cable connections in low-voltage electrical networks. Also suitable as mechanical and moisture protection on medium-voltage cable connections.

Application: For indoor and outdoor use.

#### Features and Benefits

- In a practical, transparent two-chamber pouch
- Safe-Filling system (SF)
- Excellent flow properties, low volume shrinkage
- Cold curing and very hydrophobic, to cast under the influence of water
- High hydrolytic stability and good curing at low temperatures
- UV, ageing and weather resistant
- Outstanding impact strength and resistance to moisture and atmospheric corrosion
- Excellent adhesion to polymeric cables and wires made of PVC, XLPE, PE, EPR
- SVHC-free, contains no hazardous substances, the cured product can be disposed of with house hold waste
- Halogen free



Two-component polyurethane cast resin PUR 771.

<b>MATERIAL</b>	Polyurethane resin 771 (PUR771)
<b>Colour</b>	Black (BK)
<b>Operating Temperature</b>	-25 °C to +130 °C
<b>Mixing Ratio (weight)</b>	100:22
<b>Exothermicity max.</b>	+71 °C
<b>Gel Time</b>	70 min. 5 °C, 20 min. 23 °C, 8 min. 40 °C
<b>Pot Life</b>	50 min. 5 °C, 15 min. 23 °C, 5 min. 40 °C
<b>Dielectric Strength</b>	>20 kV/mm
<b>Viscosity</b>	4000 mPa*s, 5 °C (EN ISO 2555), 2000 mPa*s, 23 °C (EN ISO 2555)
<b>Impact Strength</b>	16 kJ/m <sup>2</sup>
<b>Shore Hardness D</b>	56±5
<b>Storage Temperature</b>	+4 °C to +40 °C
<b>Shelf Life</b>	36 months



TYPE	Resin Quantity	Article-No.
Resin-771-B-SF	95 ml / 130 g	435-01214
	240 ml / 329 g	435-01215
	490 ml / 671 g	435-01216
	655 ml / 897 g	435-01217
	955 ml / 1308 g	435-01218
	1140 ml / 1562 g	435-01219
	1445 ml / 1980 g	435-01220
	1640 ml / 2247 g	435-01221
	1950 ml / 2672 g	435-01222
	2045 ml / 2802 g	435-01223

All dimensions in mm. Subject to technical changes.  
Minimum Order Quantity (MOQ) may differ from package content.

For product specific approvals please contact us under [www.HellermannTyton.com](http://www.HellermannTyton.com)

## Two-component polyurethane cast resin

### RELICON PUR 44 Flex

The RELICON PUR 44 Flex cast resin has been created for the electrical insulation, mechanical protection and repair of flexible cable connections for the low-voltage electrical network.

Application: For indoor and outdoor use.

#### Features and Benefits

- In a practical, transparent two-chamber pouch
- Safe-Filling system (SF)
- Excellent flow properties, cold curing
- Resistance to moisture and atmospheric corrosion
- Vibration absorbing, abrasion and chemical resistant
- UV, ageing and weather resistant
- Reelable and permanently flexible, even at sub-zero temperatures
- Excellent adhesion to polymeric cables and wires made of PVC, XLPE, PE, EPR
- SVHC-free, contains no hazardous substances, the cured product can be disposed of with house hold waste
- Halogen free



Two-component polyurethane cast resin PUR 44 Flex.

<b>MATERIAL</b>	Polyurethane resin 44 Flex (PUR44 Flex)
<b>Colour</b>	Black (BK)
<b>Operating Temperature</b>	-25 °C to +120 °C
<b>Mixing Ratio (weight)</b>	100:22
<b>Exothermicity max.</b>	+80 °C
<b>Gel Time</b>	35 min. 5 °C, 15 min. 23 °C, 6 min. 40 °C
<b>Pot Life</b>	35 min. 5 °C, 15 min. 23 °C, 6 min. 40 °C
<b>Dielectric Strength</b>	20 kV/mm
<b>Viscosity</b>	2500 mPa*s, 23 °C (EN ISO 2555)
<b>Shore Hardness A</b>	60±5
<b>Storage Temperature</b>	+4 °C to +40 °C
<b>Shelf Life</b>	24 months



TYPE	Resin Quantity	Article-No.
Resin-44Flex-B-SF	95 ml / 114 g	435-00350
	165 ml / 198 g	435-00351
	220 ml / 264 g	435-00352
	240 ml / 288 g	435-00353
	400 ml / 480 g	435-00354
	455 ml / 546 g	435-00355
	490 ml / 588 g	435-00356
	655 ml / 786 g	435-00357
	955 ml / 1146 g	435-00358
	1140 ml / 1368 g	435-00359
	1445 ml / 1734 g	435-00360
	1640 ml / 1968 g	435-00361
	1950 ml / 2340 g	435-00362
	2045 ml / 2454 g	435-00363

All dimensions in mm. Subject to technical changes.  
Minimum Order Quantity (MOQ) may differ from package content.

For product specific approvals please contact us under [www.HellermannTyton.com](http://www.HellermannTyton.com)



### Two-component polyurethane cast resin

#### RELICON PUR 112 FR

The RELICON PUR 112 FR cast resin is flame retardant and is used in areas with increased fire protection requirements. It has been created for electrical insulation and mechanical protection of cable connections in the low- and medium-voltage range.

Application: For indoor and outdoor use.

#### Features and Benefits

- In a practical, transparent two-chamber pouch
- Safe-Filling system (SF)
- Excellent flow properties, low volume shrinkage
- Flame retardant
- Cold curing and very hydrophobic, to cast under the influence of water
- High hydrolytic stability and good curing at low temperatures
- UV, ageing and weather resistant
- Outstanding impact strength and resistance to moisture and atmospheric corrosion
- Excellent adhesion to polymeric cables and wires made of PVC, XLPE, PE, EPR
- SVHC-free, contains no hazardous substances, the cured product can be disposed of with house hold waste
- Halogen free



Two-component polyurethane cast resin PUR 112 FR.

<b>MATERIAL</b>	Polyurethane resin 112 FR (PUR112 FR)
<b>Colour</b>	Beige (BGE)
<b>Operating Temperature</b>	-25 °C to +130 °C
<b>Mixing Ratio (weight)</b>	100:22
<b>Exothermicity max.</b>	+71 °C
<b>Gel Time</b>	70 min. 5 °C, 20 min. 23 °C, 8 min. 40 °C
<b>Pot Life</b>	50 min. 5 °C, 15 min. 23 °C, 5 min. 40 °C
<b>Dielectric Strength</b>	>20 kV/mm
<b>Viscosity</b>	1500 mPa*s, 23 °C (EN ISO 2555), 3000 mPa*s, 5 °C (EN ISO 2555)
<b>Impact Strength</b>	> 8 kJ/m <sup>2</sup>
<b>Shore Hardness D</b>	80±5
<b>Storage Temperature</b>	+4 °C to +40 °C
<b>Shelf Life</b>	36 months



TYPE	Resin Quantity	Article-No.
Resin-112FR	95 ml / 144 g	435-01100
	165 ml / 251 g	435-01101
	220 ml / 334 g	435-01102
	240 ml / 365 g	435-01103
	400 ml / 608 g	435-01104
	455 ml / 692 g	435-01105
	490 ml / 745 g	435-01106
	655 ml / 996 g	435-01107
	955 ml / 1452 g	435-01108
	1140 ml / 1733 g	435-01109
	1445 ml / 2196 g	435-01110
	1640 ml / 2493 g	435-01111
	1950 ml / 2964 g	435-01112
2045 ml / 3108 g	435-01113	

All dimensions in mm. Subject to technical changes.  
Minimum Order Quantity (MOQ) may differ from package content.

For product specific approvals please contact us under [www.HellermannTyton.com](http://www.HellermannTyton.com)



## Two-component epoxy resin

### RELICON EP 64

The RELICON EP 64 epoxy resin has been created for use in low- and medium-voltage electrical networks, especially in the chemical and oil refining industry.

Application: For indoor and outdoor use.

#### Features and Benefits

- In a practical, transparent two-chamber pouch
- Safe-Filling system (SF)
- Very hydrophobic, to cast under the influence of water
- High hydrolytic stability and good curing at low temperatures
- UV, ageing and weather resistant
- Excellent adhesion to polymeric cables and wires made of PVC, XLPE, PE, EPR
- Very high mechanical, thermal and chemical resistance
- Outstanding impact strength and resistance to moisture and atmospheric corrosion
- Halogen free



Two-component epoxy resin EP64.

<b>MATERIAL</b>	Epoxy resin EP64 (EP64)
<b>Colour</b>	Black (BK)
<b>Operating Temperature</b>	-20 °C to +140 °C
<b>Mixing Ratio (weight)</b>	100:36
<b>Exothermicity max.</b>	+140 °C
<b>Pot Life</b>	32 min. 5 °C, 13 min. 23 °C, 8 min. 35 °C
<b>Dielectric Strength</b>	>20 kV/mm
<b>Viscosity</b>	3700 mPa*s, 23 °C (EN ISO 2555)
<b>Shore Hardness D</b>	80±5
<b>Storage Temperature</b>	+4 °C to +40 °C
<b>Shelf Life</b>	48 months



TYPE	Resin Quantity	Article-No.
Resin-64-B-SF	95 ml / 107 g	435-00400
	165 ml / 186 g	435-00401
	220 ml / 249 g	435-00402
	240 ml / 271 g	435-00403
	400 ml / 452 g	435-00404
	455 ml / 514 g	435-00405
	490 ml / 554 g	435-00406
	655 ml / 740 g	435-00407
	955 ml / 1079 g	435-00408
	1140 ml / 1288 g	435-00409
	1445 ml / 1633 g	435-00410
	1640 ml / 1853 g	435-00411
	1950 ml / 2204 g	435-00412
2045 ml / 2311 g	435-00413	

All dimensions in mm. Subject to technical changes.  
Minimum Order Quantity (MOQ) may differ from package content.

For product specific approvals please contact us under [www.HellermannTyton.com](http://www.HellermannTyton.com)



### Two-component epoxy resin

#### RELICON EP 20

The RELICON EP 20 epoxy resin has been created for use in low- and medium-voltage electrical networks. It is cold curing, highly impact-resistant and the low exothermic reaction makes it possible to cast even larger volumes.

Application: For indoor and outdoor use.

#### Features and Benefits

- In a practical, transparent two-chamber pouch
- Safe-Filling system (SF)
- Low exothermic reaction
- Very hydrophobic, to cast under the influence of water
- High hydrolytic stability and good curing at low temperatures
- UV, ageing and weather resistant
- Excellent adhesion to polymeric cables and wires made of PVC, XLPE, PE, EPR
- Very high thermal and chemical resistance
- Outstanding impact strength and resistance to moisture and atmospheric corrosion
- Halogen free



Two-component epoxy resin EP20.

<b>MATERIAL</b>	Epoxy resin EP20 (EP20)
<b>Colour</b>	Yellow (YE)
<b>Operating Temperature</b>	-20 °C to +140 °C
<b>Mixing Ratio (weight)</b>	100:65
<b>Exothermicity max.</b>	+100 °C
<b>Pot Life</b>	8 min. 40 °C, 18 min. 23 °C, 35 min. 5 °C
<b>Dielectric Strength</b>	>20 kV/mm
<b>Viscosity</b>	2000 mPa*s, 23 °C (EN ISO 2555)
<b>Shore Hardness D</b>	70±5
<b>Storage Temperature</b>	+4 °C to +40 °C
<b>Shelf Life</b>	48 months



TYPE	Resin Quantity	Article-No.
Resin-20-B-SF	95 ml / 103 g	435-00450
	165 ml / 178 g	435-00451
	220 ml / 238 g	435-00452
	240 ml / 259 g	435-00453
	400 ml / 432 g	435-00454
	455 ml / 491 g	435-00455
	490 ml / 529 g	435-00456
	655 ml / 707 g	435-00457
	955 ml / 1031 g	435-00458
	1140 ml / 1231 g	435-00459
	1445 ml / 1561 g	435-00460
	1640 ml / 1771 g	435-00461
	1950 ml / 2106 g	435-00462
	2045 ml / 2209 g	435-00463

All dimensions in mm. Subject to technical changes.  
Minimum Order Quantity (MOQ) may differ from package content.

For product specific approvals please contact us under [www.HellermannTyton.com](http://www.HellermannTyton.com)

## Two-component cold casting compound

### RELICON Reliflex

The RELICON Reliflex cast resin is a non-toxic cold casting compound based on hydrocarbon resins for the low-voltage electrical networks. The very hydrophobic resin has been created for electrical insulation and moisture protection of cable connections. After curing, Reliflex is extremely resistant to moisture and has excellent insulating properties.

Application: For indoor and outdoor use.

#### Features and Benefits

- In a practical, transparent two-chamber pouch
- Colour changes from beige to yellow whilst mixing
- Safe-Filling system (SF)
- Excellent flow properties, low volume shrinkage
- Fast gelling, curing without developing heat
- Cold curing and very hydrophobic, to cast under the influence of water
- High hydrolytic stability and good curing at low temperatures
- UV, ageing and weather resistant
- Excellent adhesion to polymeric cables and wires made of PVC, XLPE, PE, EPR
- Resistance to moisture and atmospheric corrosion
- Soft elastic, vibration absorbing, removable
- Non-toxic, free of silicone and isocyanate
- SVHC-free, contains no hazardous substances, the cured product can be disposed of with house hold waste



Two-component cold casting compound Reliflex.

<b>MATERIAL</b>	Cold sealing compound Reliflex (Reliflex)
<b>Colour</b>	Yellow (YE)
<b>Operating Temperature</b>	-40 °C to +90 °C
<b>Mixing Ratio (weight)</b>	100:40
<b>Exothermicity max.</b>	-
<b>Gel Time</b>	45 min. 5 °C, 25 min. 23 °C, 14 min. 40° C
<b>Pot Life</b>	40 min. 5 °C, 20 min. 23 °C, 10 min. 40 °C
<b>Dielectric Strength</b>	>10 kV/mm
<b>Viscosity</b>	5000 mPa*s, 5 °C (EN ISO 2555), 3300 mPa*s, 23 °C (EN ISO 2555)
<b>Shore Hardness A</b>	20±5
<b>Storage Temperature</b>	+4 °C to +40 °C
<b>Shelf Life</b>	36 months



TYPE	Resin Quantity	Article-No.
Resin-RF-B-SF	95 ml / 116 g	435-00550
	165 ml / 201 g	435-00551
	220 ml / 268 g	435-00552
	240 ml / 293 g	435-00553
	400 ml / 488 g	435-00554
	455 ml / 555 g	435-00555
	490 ml / 598 g	435-00556
	655 ml / 799 g	435-00557
	955 ml / 1165 g	435-00558
	1140 ml / 1391 g	435-00559
	1445 ml / 1763 g	435-00560
	1640 ml / 2001 g	435-00561
	1950 ml / 2379 g	435-00562
	2045 ml / 2495 g	435-00563

All dimensions in mm. Subject to technical changes.  
Minimum Order Quantity (MOQ) may differ from package content.

For product specific approvals please contact us under [www.HellermannTyton.com](http://www.HellermannTyton.com)



### Two-component polyurethane sealing mastic

#### RELICON PUR DS

The RELICON PUR DS cast resin is a chemically thixotropic, universal polyurethane sealing mastic. It is ideal for sealing wall feed-throughs as well as other filling and sealing applications.

#### Features and Benefits

- In a practical, transparent two-chamber pouch
- Colour changes from black to grey whilst mixing
- Safe-Filling system (SF)
- Very thixotropic and high stability
- Gas and water tight to 1.5 bar
- Excellent adhesion to concrete and stone. Also on polymeric cables and wires made of PVC, XLPE, PE, EPR
- Soft elastic
- Spatula included
- SVHC-free, contains no hazardous substances, the cured product can be disposed of with house hold waste
- Halogen free



Two-component polyurethane cast resin PUR DS.

<b>MATERIAL</b>	Polyurethane (PUR)
<b>Colour</b>	Grey (GY)
<b>Operating Temperature</b>	-25 °C to +110 °C
<b>Mixing Ratio (weight)</b>	100:52
<b>Pot Life</b>	15 min. 23 °C
<b>Shore Hardness D</b>	30±5
<b>Storage Temperature</b>	+4 °C to +40 °C
<b>Shelf Life</b>	24 months



**System solutions for wall ducts can be found on pages: 58, 59.**



TYPE	Resin Quantity	Article-No.
Resin-DS-B-SF	250 ml / 275 g	435-00600
	490 ml / 539 g	435-00601

All dimensions in mm. Subject to technical changes.  
Minimum Order Quantity (MOQ) may differ from package content.

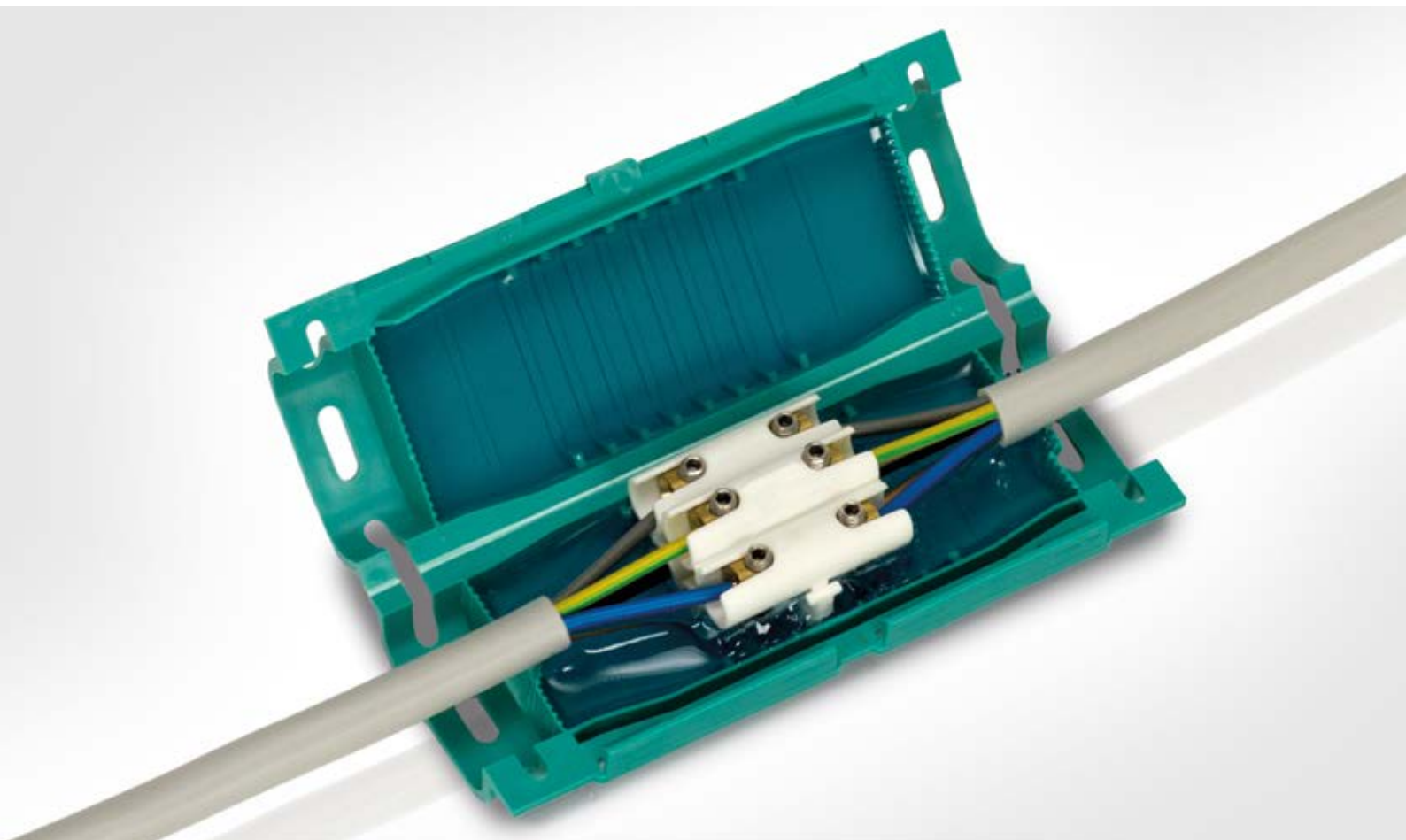

## Gel Technology

### Gel cable joint with connector

RELICON Reliseal Overview	38
RELICON Reliseal V 56, V 510, V 525	39
RELICON Relilight Overview	40
RELICON Relilight V 2.75 I1	42
RELICON Relilight V 31.5 U1	42
RELICON Relilight V 32.5 I2	43
RELICON Relilight V 32.5 P1	43
RELICON Relilight V 34 P2	44
RELICON Relilight V 36 P2	44
RELICON Relilight V 41.5 P1	45
RELICON Relilight V 41 U1	45
RELICON Relilight V 61.5 I2	46

### Gel cable joint without connector

RELICON Relifix	48
-----------------	----

### Gel cable joint with connector

RELICON Relifix V	49
RELICON Relifix VY	50

### Gel accessories

RELICON Relifix ZE	51
--------------------	----

### Two-component gel

RELICON KH 67	53
RELICON KH 100	55

### Two-component silicone gel

RELICON Religel	54
-----------------	----



## RELICON Reliseal gel cable joints: for connections under extreme conditions

Reliseal gel cable joints are designed for reliability and robustness under the toughest conditions. They are tested to IP68 (waterproof to 10 meters) and feature an integrated strain relief mechanism that ensures maximum protection, insulation and sealing of cable connections in extreme environments.

Ready-to-use out of the box, fitting is quick and easy.





## Gel cable joint with connector

### RELICON Reliseal

Reliseal gel cable joints are suitable for cable connections under extreme conditions, outdoors and underground. They are universal straight-through joints with a protection class IP68 and consist of a solid polypropylene shell (PP) filled with RELICON gel. They can be used for jointing on polymeric cables and wires made of PVC, XLPE, PE, EPR, etc. Reliseal fulfils the highest requirements for electrical installations and offers mechanical protection, insulation and sealing in one work step. The installer saves time and requires no special installation tools.

Application: In low-voltage electrical networks as straight-through joint. Underground, submerged, outdoor, indoor and in wiring ducts.

### Features and Benefits

- Moulding shell: one piece, re-openable, impact-proof, flame retardant
- Perfect strain relief provided by patented cable gland system
- Protection class IP68, 10 m
- Filled with RELICON non-toxic gel, high dielectric strength
- No mixing, easy to install
- UV, ageing and weather resistant
- Unlimited shelf life
- With connector, ready to assembly

### Content of Set / Kit

- Moulding shells filled with RELICON gel
- Cable gland system for strain relief and transverse waterproofing
- Adapter seal for different cable diameters
- Installation instructions
- Connector



Reliseal gel cable joint, available in three sizes.



Gel cable joint Reliseal V 56.



Gel cable joint Reliseal V 510.



Gel cable joint Reliseal V 525.

**i With connector!**

**i IP68, 10 meter**

<b>MATERIAL</b>	Polypropylene (PP), Silicone (SI)
<b>Colour</b>	Green (GN)
<b>Operating Temperature</b>	-20 °C to +90 °C
<b>Shelf Life</b>	Unlimited

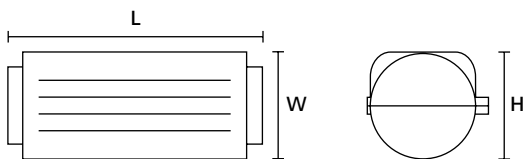

Reliseal V

**RoHS** ✓

TYPE	Main Cable mm <sup>2</sup> min - max		Length (L)	Width (W)	Height (H)	Article-No.
<b>Reliseal V56</b>	3 x 2,5	5 x 6	190.0	60.0	47.0	435-01660
<b>Reliseal V510</b>	3 x 4	5 x 10	235.0	69.0	49.0	435-01661
<b>Reliseal V525</b>	3 x 10	5 x 25	310.0	88.0	60.0	435-01662

All dimensions in mm. Subject to technical changes.  
Minimum Order Quantity (MOQ) may differ from package content.

For product specific approvals please contact us under [www.HellermannTyton.com](http://www.HellermannTyton.com)

## RELICON Relilight gel cable joints: specially designed for the needs of lighting installers to connect and branch small conductor cross-sections

Relilight gel cable joints are designed for safely connecting and branching off the small cable cross-sections now commonly used in lighting installations. Relilight's compact dimensions, integrated strain relief and IP68 safety class make it an ideal product for reliable connections in confined spaces and under wet or dusty conditions.

RELICON Relilight is tested to DIN EN 60998-2-1:2004. It is resistant to ageing and weathering and withstands temperatures from -30 to +130 °C.







## Gel cable joint with connector

### RELICON Relilight

Relilight gel cable joints are designed for light installations, especially LED lighting. They are tested according to DIN EN 60998-2-1: 2004 and offer IP68 protection class. The moulding shells are also flame retardant. Depending on the connector type, Relilight can be used either for straight-through or as branch joints. They are suitable for jointing on polymeric cables and wires made of PVC, XLPE, PE, EPR etc. The silicone-based RELICON gel in the Relilight cable joints provides insulation, sealing and mechanical protection in one step. Furthermore, they reduce the workload and total cost of installation.

Application: In low-voltage electrical networks as straight-through or branch joints, e.g. for outdoor light installations, underground, submerged, outdoor, indoor and in wiring ducts.

### Features and Benefits

- Moulding shell: two piece, black, re-openable, with strain relief, flame retardant, protection class IP68, 1.3 m
- Filled with Relicon non-toxic gel, high dielectric strength >1kV,
- No mixing, ready to assembly
- UV, ageing and weather resistant
- Compact dimensions, with connector
- Unlimited shelf life
- Certified according to DIN EN 60998-2-1:2004

### Content of Set / Kit

- Moulding shells filled with RELICON gel
- Adapter for strain relief (not for No. 435-01650)
- Installation instructions, connector block, screws
- Wire guide (only No. 435-01654)

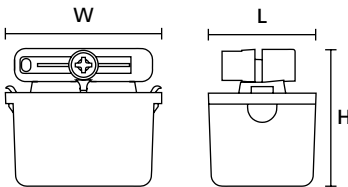

Relilight gel cable joint.

<b>MATERIAL</b>	Polyamide 6.6 V0 (PA66V0), Silicone (SI)
<b>Colour</b>	Black (BK)
<b>Operating Temperature</b>	-30 °C to +130 °C
<b>Shelf Life</b>	Unlimited



**i** With connector block!

**i** IP68, 1.3 meter

TYPE	Ø Main Cable	Main Cable mm <sup>2</sup> min - max		Branch Cable mm <sup>2</sup> min - max		Voltage range	Length (L)	Width (W)	Height (H)	Article-No.
Relilight V2.75 I1	4.8-6	2 x 0.35	2 x 0.75	-	-	250V, 6A	44.0	18.0	17.5	435-01650
Relilight V32.5 I2	6.5-12	3 x 0.5	3 x 2.5	-	-	250V, 16A	100.0	24.0	29.0	435-01651
Relilight V32.5 P1	6.5-12	3 x 0.5	3 x 2.5	3 x 0.5	3 x 2.5	250V, 16A	105.0	44.0	24.0	435-01655
Relilight V41.5 P1	6.5-12	4 x 0.5	4 x 1.5	4 x 0.5	4 x 1.5	250V, 16A	105.0	44.0	24.0	435-01656
Relilight V61.5 I2	6.5-12	6 x 0.5	6 x 1.5	-	-	12V - 24V	100.0	24.0	29.0	435-01652
Relilight V34 P2	7.5-16	3 x 1.5	3 x 4	3 x 1.5	3 x 4	450V, 25A	138.0	78.0	35.0	435-01657
Relilight V36 P2	7.5-16	3 x 1.5	3 x 6	3 x 1.5	3 x 6	450V, 25A	138.0	78.0	35.0	435-01658
Relilight V31.5 U1	8.0-10	3 x 0.5	3 x 1.5	-	-	250V, 16A	38.0	42.5	29.5	435-01653
Relilight V41 U1	8.0-10	4 x 0.5 / 6 x 0.35	4 x 1 / 6 x 0.5	-	-	12V - 24V	38.0	42.5	29.5	435-01654

All dimensions in mm. Subject to technical changes.  
Minimum Order Quantity (MOQ) may differ from package content.

For product specific approvals please contact us under [www.HellermannTyton.com](http://www.HellermannTyton.com)



## RELICON Relilight V 2.75 I1

### Content of Set / Kit

- Moulding shells filled with RELICON gel
- Installation instructions
- Connector block 2 x 0.35 mm<sup>2</sup> to 2 x 0.75 mm<sup>2</sup>
- Screw

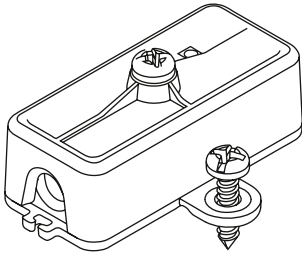

Relilight V 2.75 I1



Gel cable joint Relilight V 2.75 I1.

TYPE	Ø Main Cable	Main Cable mm <sup>2</sup> min - max		Voltage range	Length (L)	Width (W)	Height (H)	Article-No.
Relilight V2.75 I1	4.8-6	2 x 0.35	2 x 0.75	250V, 6A	44.0	18.0	17.5	435-01650

All dimensions in mm. Subject to technical changes.  
Minimum Order Quantity (MOQ) may differ from package content.

## RELICON Relilight V 31.5 U1

### Content of Set / Kit

- Moulding shells filled with RELICON gel
- Installation instructions
- Connector block 3 x 0.5 mm<sup>2</sup> to 3 x 1.5 mm<sup>2</sup>
- Screw

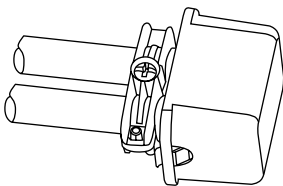

Relilight V 31.5 U1



Gel cable joint Relilight V 31.5 U1.

TYPE	Ø Main Cable	Main Cable mm <sup>2</sup> min - max		Voltage range	Length (L)	Width (W)	Height (H)	Article-No.
Relilight V31.5 U1	8.0-10	3 x 0.5	3 x 1.5	250V, 16A	38.0	42.5	29.5	435-01653

All dimensions in mm. Subject to technical changes.  
Minimum Order Quantity (MOQ) may differ from package content.

For product specific approvals please contact us under [www.HellermannTyton.com](http://www.HellermannTyton.com)





## RELICON Relilight V 32.5 I2

### Content of Set / Kit

- Moulding shells filled with RELICON gel
- Adapter for strain relief
- Installation instructions
- Connector block 3 x 0.5 mm<sup>2</sup> to 3 x 2.5 mm<sup>2</sup>
- Screws

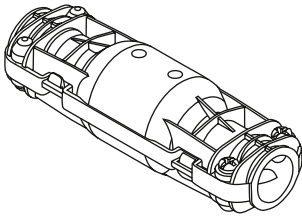

Relilight V 32.5 I2



Gel cable joint Relilight V 32.5 I2.

TYPE	Ø Main Cable	Main Cable mm <sup>2</sup> min - max		Voltage range	Length (L)	Width (W)	Height (H)	Article-No.
		3 x 0.5	3 x 2.5					
Relilight V32.5 I2	6.5-12	3 x 0.5	3 x 2.5	250V, 16A	100.0	24.0	29.0	435-01651

All dimensions in mm. Subject to technical changes.  
Minimum Order Quantity (MOQ) may differ from package content.

## RELICON Relilight V 32.5 P1

### Content of Set / Kit

- Moulding shells filled with RELICON gel
- Adapter for strain relief
- Installation instructions
- Connector block 3 x 0.5 mm<sup>2</sup> to 3 x 2.5 mm<sup>2</sup>
- Screws

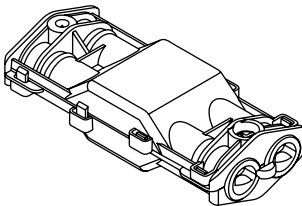

Relilight V 32.5 P1



Gel cable joint Relilight V 32.5 P1.

TYPE	Ø Main Cable	Main Cable mm <sup>2</sup> min - max		Branch Cable mm <sup>2</sup> min - max		Voltage range	Length (L)	Width (W)	Height (H)	Article-No.
		3 x 0.5	3 x 2.5	3 x 0.5	3 x 2.5					
Relilight V32.5 P1	6.5-12	3 x 0.5	3 x 2.5	3 x 0.5	3 x 2.5	250V, 16A	105.0	44.0	24.0	435-01655

All dimensions in mm. Subject to technical changes.  
Minimum Order Quantity (MOQ) may differ from package content.



## RELICON Relilight V 34 P2

### Content of Set / Kit

- Moulding shells filled with RELICON gel
- Adapter for strain relief
- Installation instructions
- Connector block 3 x 1.5 mm<sup>2</sup> to 3 x 4 mm<sup>2</sup>
- Screws

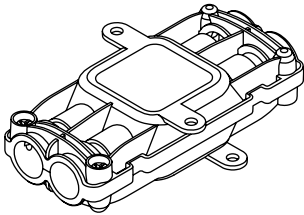

Relilight V 34 P2



Gel cable joint Relilight V 34 P2.

TYPE	Ø Main Cable	Main Cable mm <sup>2</sup> min - max		Branch Cable mm <sup>2</sup> min - max		Voltage range	Length (L)	Width (W)	Height (H)	Article-No.
		3 x 1.5	3 x 4	3 x 1.5	3 x 4					
Relilight V34 P2	7.5-16	3 x 1.5	3 x 4	3 x 1.5	3 x 4	450V, 25A	138.0	78.0	35.0	435-01657

All dimensions in mm. Subject to technical changes.  
Minimum Order Quantity (MOQ) may differ from package content.

## RELICON Relilight V 36 P2

### Content of Set / Kit

- Moulding shells filled with RELICON gel
- Adapter for strain relief
- Installation instructions
- Connector block 3 x 1.5 mm<sup>2</sup> to 3 x 6 mm<sup>2</sup>
- Screws

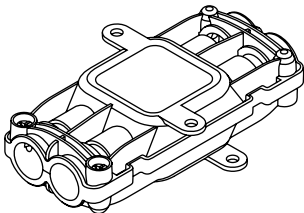

Relilight V 36 P2



Gel cable joint Relilight V 36 P2.

TYPE	Ø Main Cable	Main Cable mm <sup>2</sup> min - max		Branch Cable mm <sup>2</sup> min - max		Voltage range	Length (L)	Width (W)	Height (H)	Article-No.
		3 x 1.5	3 x 6	3 x 1.5	3 x 6					
Relilight V36 P2	7.5-16	3 x 1.5	3 x 6	3 x 1.5	3 x 6	450V, 25A	138.0	78.0	35.0	435-01658

All dimensions in mm. Subject to technical changes.  
Minimum Order Quantity (MOQ) may differ from package content.



## RELICON Relilight V 41.5 P1

### Content of Set / Kit

- Moulding shells filled with RELICON gel
- Adapter for strain relief
- Installation instructions
- Connector block 4 x 0.5 mm<sup>2</sup> to 4 x 1.5 mm<sup>2</sup>
- Screws

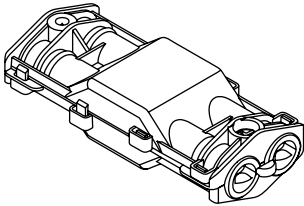

Relilight V 41.5 P1



Gel cable joint Relilight V 41,5 P1.

TYPE	Ø Main Cable	Main Cable mm <sup>2</sup> min - max		Branch Cable mm <sup>2</sup> min - max		Voltage range	Length (L)	Width (W)	Height (H)	Article-No.
		4 x 0.5	4 x 1.5	4 x 0.5	4 x 1.5					
Relilight V41.5 P1	6.5-12	4 x 0.5	4 x 1.5	4 x 0.5	4 x 1.5	250V, 16A	105.0	44.0	24.0	435-01656

All dimensions in mm. Subject to technical changes.  
Minimum Order Quantity (MOQ) may differ from package content.

## RELICON Relilight V 41 U1

### Content of Set / Kit

- Moulding shells filled with RELICON gel
- Installation instructions
- Connector block 4 x 0.5 mm<sup>2</sup> to 4 x 1 mm<sup>2</sup>
- Wire guide 6 x 0.35 mm<sup>2</sup> to 6 x 0.5 mm<sup>2</sup> (solder)
- Screw

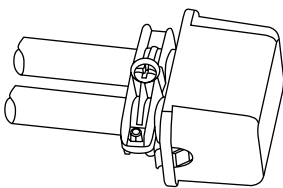

Relilight V 41 U1



Gel cable joint Relilight V 41 U1.

TYPE	Ø Main Cable	Main Cable mm <sup>2</sup> min - max		Voltage range	Length (L)	Width (W)	Height (H)	Article-No.
		4 x 0.5 / 6 x 0.35	4 x 1 / 6 x 0.5					
Relilight V41 U1	8.0-10	4 x 0.5 / 6 x 0.35	4 x 1 / 6 x 0.5	12V - 24V	38.0	42.5	29.5	435-01654

All dimensions in mm. Subject to technical changes.  
Minimum Order Quantity (MOQ) may differ from package content.



## RELICON Relilight V 61.5 I2

### Content of Set / Kit

- Moulding shells filled with RELICON gel
- Adapter for strain relief
- Installation instructions
- Connector block 6 x 0.5 mm<sup>2</sup> to 6 x 1.5 mm<sup>2</sup>
- Screws

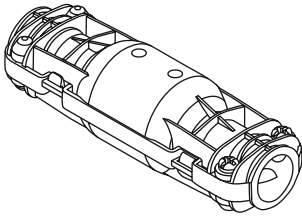

Relilight V 61.5 I2



Gel cable joint Relilight V 61.5 I2.

TYPE	Ø Main Cable	Main Cable mm <sup>2</sup> min - max		Voltage range	Length (L)	Width (W)	Height (H)	Article-No.
		6 x 0.5	6 x 1.5					
Relilight V61.5 I2	6.5-12	6 x 0.5	6 x 1.5	12V - 24V	100.0	24.0	29.0	435-01652

All dimensions in mm. Subject to technical changes.  
Minimum Order Quantity (MOQ) may differ from package content.

## RELICON Relifix gel cable joints: quick and effortless application

RELICON gel cable joints, which are used for cable connections above and below ground, consist of a robust polypropylene sleeve plus RELICON gel. RELICON gel products comply with the highest electrical engineering requirements and provide mechanical protection, insulation and sealing in a single work step. The fitter saves time and needs no special installation tools. RELICON gel cable joints can be used up to conductor temperatures of +90 °C. The material is non-hazardous and has an unlimited shelf-life. RELICON gel cable joints are suitable for straight-through or branch connections. They are available in different sizes, covering the common range of conductor cross sections. The products comply with the major European standards DIN EN 50393 (corresponding to DIN VDE 0278).







## Gel cable joint without connector

### RELICON Relifix

RELICON Relifix gel technology offers several advantages. It is quick and easy to install. The moulding shells are provided with a film hinge and are made from thick-walled, tough and impact resistant polypropylene (PP). The Relicon gel in the shells insulates and seals the complete connection as the joint is closed. Depending on the connector type, Relifix can be used as a universal straight-through or branch joint. It is suitable for jointing on polymeric cables and wires made of PVC, XLPE, PE, EPR etc.

Application: In low-voltage electrical networks as straight-through and/or branch joint, e.g. underground, submerged, outdoor, indoor and wiring ducts.

### Features and Benefits

- Moulding shell: One piece, coloured, re-openable, impact-proof, flame retardant
- Filled with Relicon non-toxic gel, high dielectric strength
- No mixing, easy to install
- UV, ageing and weather resistant
- Unlimited shelf life
- Certified according to DIN EN 50393 (corresponds to DIN VDE 0278-393)

### Content of Set / Kit

- Moulding shells filled with RELICON gel
- Installation instructions
- Separator plate
- Cable ties

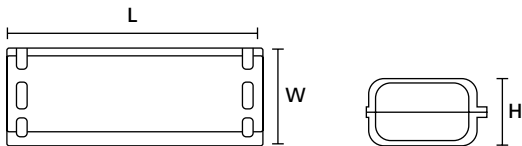

Relifix 410, 416

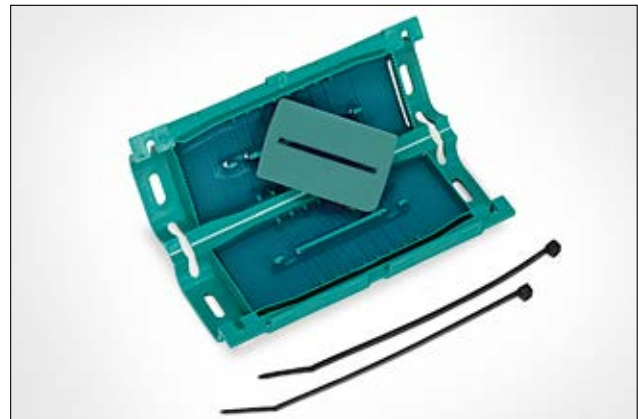

Gel cable joint Relifix 410, 416.

<b>MATERIAL</b>	Polypropylene (PP), Silicone (SI)
<b>Colour</b>	Green (GN)
<b>Operating Temperature</b>	-20 °C to +90 °C
<b>Shelf Life</b>	Unlimited



**i** Without connector block!

TYPE	Ø Main Cable	Main Cable mm <sup>2</sup>		Branch Cable mm <sup>2</sup>		Length (L)	Width (W)	Height (H)	Article-No.
		min	max	min	max				
<b>Relifix 410</b>	9-20	3 x 1.5	4 x 10	3 x 1.5	4 x 2.5	146.0	55.0	35.0	435-00652
<b>Relifix 416</b>	9-22	3 x 1.5	4 x 16	3 x 1.5	4 x 4	180.0	69.0	40.0	435-00653

All dimensions in mm. Subject to technical changes.  
Minimum Order Quantity (MOQ) may differ from package content.



## Gel cable joint with connector

### RELICON Relifix V

RELICON Relifix gel technology offers several advantages. It is quick and easy to install. The moulding shells are provided with a film hinge and are made from thick-walled, tough and impact resistant polypropylene (PP). The Relicon gel in the shells insulates and seals the complete connection as the joint is closed. Depending on the connector type, Relifix can be used as a universal straight-through or branch joint. It is suitable for jointing on polymeric cables and wires made of PVC, XLPE, PE, EPR etc.

Application: In low-voltage electrical networks as straight-through and/or branch joint, e.g. underground, submerged, outdoor, indoor and wiring ducts.



Gel cable joint Relifix V in use as a cable repair.

### Features and Benefits

- Moulding shell: One piece, coloured, re-openable, impact-proof, flame retardant
- Filled with Relicon non-toxic gel, high dielectric strength
- No mixing, easy to install
- UV, ageing and weather resistant
- Unlimited shelf life
- With connector, ready for assembly
- Certified according to DIN EN 50393 (corresponds to DIN VDE 0278-393)

### Content of Set / Kit

- Moulding shells filled with RELICON gel
- Installation instructions
- Connector
- Cable ties
- Allen key (not for type V31,5)



Gel cable joint Relifix V 31,5.

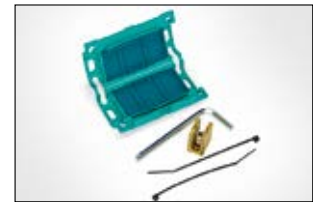

Gel cable joint Relifix V 150.



Gel cable joint Relifix V 56, V516.



Gel cable joint Relifix V 525.

**With connector block!**

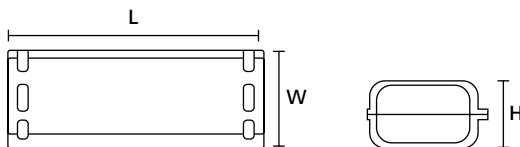

Relifix V

<b>MATERIAL</b>	Polypropylene (PP), Silicone (SI)
<b>Colour</b>	Green (GN)
<b>Operating Temperature</b>	-20 °C to +90 °C
<b>Shelf Life</b>	Unlimited

**RoHS** ✓

TYPE	Ø Main Cable	Main Cable mm <sup>2</sup> min - max		Branch Cable mm <sup>2</sup> min - max		Length (L)	Width (W)	Height (H)	Article-No.
Relifix V150	9-16	1 x 10	1 x 50	1 x 2,5	1 x 6	86.0	47.0	27.0	435-00651
Relifix V31.5	9-16	3 x 0,5	3 x 2,5	-	-	86.0	47.0	27.0	435-00650
Relifix V56	9-20	3 x 1,5	5 x 6	-	-	146.0	55.0	35.0	435-00654
Relifix V516	9-22	3 x 6	5 x 16	-	-	180.0	69.0	40.0	435-00655
Relifix V525	9-30	3 x 16	5 x 25	-	-	240.0	75.0	48.0	435-00656

All dimensions in mm. Subject to technical changes.  
Minimum Order Quantity (MOQ) may differ from package content.

For product specific approvals please contact us under [www.HellermannTyton.com](http://www.HellermannTyton.com)



## Gel cable joint with connector

### RELICON Relifix VY

RELICON Relifix gel technology offers several advantages. It is quick and easy to install. The moulding shells are provided with a film hinge and are made from thick-walled, tough and impact resistant polypropylene (PP). The Relicon gel in the shells insulates and seals the complete connection as the joint is closed. Depending on the connector type, Relifix can be used as a universal straight-through or branch joint. It is suitable for jointing on polymeric cables and wires made of PVC, XLPE, PE, EPR etc.

Application: In low-voltage electrical networks as straight-through and/or branch joint, e.g. underground, submerged, outdoor, indoor and wiring ducts.

### Features and Benefits

- Moulding shell: One piece, coloured, re-openable, impact-proof, flame retardant
- Filled with Relicon non-toxic gel, high dielectric strength
- No mixing, easy to install
- UV, ageing and weather resistant
- Unlimited shelf life
- With connector, ready for assembly
- Certified according to DIN EN 50393 (corresponds to DIN VDE 0278-393)

### Content of Set / Kit

- Moulding shells filled with RELICON gel
- Installation instructions
- Connector
- Cable ties
- Allen key



**With connector block!**

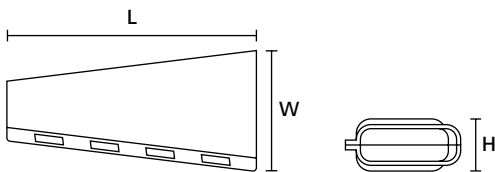

Relifix VY



Relicon Relifix VY gel cable joint.



Gel cable joint Relifix V 135Y.



Gel cable joint Relifix V 506Y.



Gel cable joint Relifix V 525Y.

<b>MATERIAL</b>	Polypropylene (PP), Silicone (SI)
<b>Colour</b>	Green (GN)
<b>Operating Temperature</b>	-20 °C to +90 °C
<b>Shelf Life</b>	Unlimited



TYPE	Ø Main Cable	Main Cable mm <sup>2</sup> min - max		Branch Cable mm <sup>2</sup> min - max		Length (L)	Width (W)	Height (H)	Article-No.
Relifix V 135Y	9-16	1 x 10	1 x 35	1 x 2.5	1 x 25	145.0	70.0	32.0	435-00657
Relifix V 506Y	9-20	3 x 6	5 x 6	3 x 2.5	5 x 6	220.0	110.0	53.0	435-00658
Relifix V 525Y	9-30	3 x 16	5 x 25	3 x 2.5	5 x 25	260.0	130.0	65.0	435-00659

All dimensions in mm. Subject to technical changes.  
Minimum Order Quantity (MOQ) may differ from package content.

For product specific approvals please contact us under [www.HellermannTyton.com](http://www.HellermannTyton.com)



## Gel accessories

### RELICON Relifix ZE

Relifix ZE is an optional accessory providing strain relief when using cable joints Relifix 416, Relifix V516 and Relifix V525. Suitable for conductor cross-sections from 6 mm<sup>2</sup> to 25 mm<sup>2</sup>.

#### Features and Benefits

- Releasable strain relief
- Quick and easy installation
- Only for Relifix 416, V516, V525
- For conductor cross-sections of 6 -25 mm<sup>2</sup>

#### Content of Set / Kit

- 2 Relifix ZE each with two fixing screws
- Installation instructions

TYPE	Article-No.
Relifix ZE	435-00700

All dimensions in mm. Subject to technical changes.  
Minimum Order Quantity (MOQ) may differ from package content.



Gel accessory Relifix ZE.

<b>MATERIAL</b>	Polypropylene (PP)
<b>Colour</b>	Grey (GY)
<b>Operating Temperature</b>	-20 °C to +90 °C
<b>Shelf Life</b>	Unlimited





## RELICON two-component gels: individually dosable – quick to handle

RELICON two-component gels offer excellent insulating properties, good chemical resistance and excellent resistance to moisture.

Versatile use – for example encapsulating electronic components – the product is quick to handle and can be easily dosed according to individual requirements.





### Two-component gel

#### RELICON KH 67

RELICON KH 67 is a transparent, removable, saltwater resistant, flexible two-component gel based on hydrocarbon resins. It is especially suitable for use with junction boxes in low-voltage networks, located in a humid area or in the ground. After curing, RELICON KH 67 is characterised by its excellent resistance to moisture and very good insulating properties as well as good chemical resistance.

Application: Electrical insulation and moisture protection in the low-voltage networks. Particularly suitable for filling of cable junction boxes.

#### Features and Benefits

- A practical, transparent two-chamber pouch
- Safe-Filling system (SF)
- Excellent flow properties
- Soft elastic, vibration absorbing, removable
- Outstanding insulating properties
- Cures without developing heat
- Saltwater resistant
- Non-toxic, free of silicone and isocyanate
- SVHC-free, contains no hazardous substances, the cured product can be disposed of with house hold waste
- Halogen free



Two-component gel KH 67.

<b>MATERIAL</b>	Gel KH67 (KH67)
<b>Colour</b>	Transparent (CL), Yellow (YE)
<b>Operating Temperature</b>	-40 °C to +90 °C
<b>Mixing Ratio (weight)</b>	100:67
<b>Pot Life</b>	40 min. 23 °C
<b>Density</b>	0.95 g/cm <sup>3</sup> , 20 °C (DIN EN ISO 2811-2)
<b>Dielectric Strength</b>	>15 kV/mm
<b>Viscosity</b>	3000 mPa*s, 5 °C (EN ISO 2555), 2000 mPa*s, 23 °C (EN ISO 2555)
<b>Storage Temperature</b>	+4 °C to +40 °C
<b>Shelf Life</b>	36 months



**Silicon free!**



TYPE	Pack Cont.	Article-No.
<b>Gel-67-B-SF</b>	180 ml	435-00800
	250 ml	435-00801
	600 ml	435-00802
	750 ml	435-00803
	1,200 ml	435-00804

All dimensions in mm. Subject to technical changes.  
Minimum Order Quantity (MOQ) may differ from package content.



## Two-component silicone gel

### RELICON Religel

RELICON Religel is a transparent, elastic two-component silicone gel. It is delivered in practical transparent bottles or canisters. It is particularly suited to fill junction boxes in low-voltage applications. After curing, RELICON Religel gives excellent resistance to moisture, has high insulating properties and very good chemical resistance.

Application: Electrical insulation and moisture protection for low-voltage applications, particularly suitable for insulating cables and wires in junction boxes.

#### Features and Benefits

- Bottles or canisters incl. measuring cup and mixing stick
- Homogenous mixture indicated by green-coloured component B
- Can be used flexibly, in smaller quantities, mixing ratio 1:1
- Excellent flow properties
- Soft elastic, vibration absorbing, removable
- Outstanding insulating properties
- Non-toxic, free of isocyanate
- SVHC-free, contains no hazardous substances, the cured product can be disposed of with house hold waste
- Halogen free



Two-component silicone gel Religel.



Two-component silicone gel Religel.

<b>MATERIAL</b>	Silicone gel Religel (SIG)
<b>Colour</b>	Transparent (CL), Green (GN)
<b>Operating Temperature</b>	-40 °C to +140 °C
<b>Mixing Ratio (weight)</b>	100:100
<b>Gel Time</b>	20 min. 23 °C
<b>Pot Life</b>	10 min. 23 °C
<b>Density</b>	0.97 g/cm <sup>3</sup> , 20 °C (DIN EN ISO 2811-2)
<b>Dielectric Strength</b>	>20 kV/mm
<b>Viscosity</b>	1000 mPa*s, 23 °C (EN ISO 2555), 1500 mPa*s, 5 °C (EN ISO 2555)
<b>Storage Temperature</b>	+4 °C to +40 °C
<b>Shelf Life</b>	Unlimited



TYPE	Pack Cont.	Article-No.
Religel	1,000 ml	435-00750
	10,000 ml	435-00751

All dimensions in mm. Subject to technical changes.  
Minimum Order Quantity (MOQ) may differ from package content.

For product specific approvals please contact us under [www.HellermannTyton.com](http://www.HellermannTyton.com)



### Two-component gel

#### RELICON KH 100

RELICON KH 100 is a transparent, removable, saltwater resistant, flexible two-component gel based on hydrocarbon resins in trade standard cartridges. It is especially suitable for use with junction boxes in the low-voltage range, located in a humid area or in the ground. After curing, RELICON KH 100 is characterised by its excellent resistance to moisture and very good insulating properties as well as good chemical resistance.

Application: Electrical insulation and moisture protection for the low-voltage networks. Particularly suitable for filling of cable junction boxes.

#### Features and Benefits

- Cartridge with mixing nozzle for use with standard cartridge applicator gun
- Excellent flow properties
- Soft elastic, vibration absorbing, removable
- Outstanding insulating properties
- Cures without developing heat
- Saltwater resistant
- Non-toxic, free of silicone and isocyanate
- SVHC-free, contains no hazardous substances, the cured product can be disposed of with house hold waste
- Halogen free



Two-component gel KH 100.

<b>MATERIAL</b>	Gel KH100 (KH100)
<b>Colour</b>	Transparent (CL), Orange (OG)
<b>Operating Temperature</b>	-40 °C to +90 °C
<b>Mixing Ratio (weight)</b>	1:1
<b>Pot Life</b>	40 min. 23 °C
<b>Density</b>	0.95 g/cm <sup>3</sup> , 20 °C (DIN EN ISO 2811-2)
<b>Dielectric Strength</b>	>20 kV/mm
<b>Viscosity</b>	2000 mPa*s, 5 °C (EN ISO 2555), 1500 mPa*s, 23 °C (EN ISO 2555)
<b>Storage Temperature</b>	+4 °C to +40 °C
<b>Shelf Life</b>	18 months



**Silicon free!**



TYPE	Pack Cont.	Article-No.
Gel-100 Mixing-Nozzle	10 pcs.	435-00806
Gel-100	250 ml	435-00805
	600 ml	435-00807

All dimensions in mm. Subject to technical changes.  
Minimum Order Quantity (MOQ) may differ from package content.



# HelaTape. The Tape-Team.

A professional team of electrical and technical tapes for bundling, insulating, fixing, sealing and marking.





## Accessories

<b>Hand cleaning tissues</b>		
	RELICON Reliclean	58
<b>Centering sealing foam</b>		
for wall feed-throughs	RELICON WSHEZ	58
<b>Heat shrinkable wall</b>		
for feed-throughs	RELICON WSHE	59
<b>Connectors</b>		
Compression connector, tin-plated	with central buttmark for copper conductors	60
Mechanical connector, tin-plated	with barrier and shear-off bolts for Al and CU conductors	61
	with blind hole for Al and CU conductors	61
Tap connector, uninsulated	for copper conductors	62
	for insulated aluminium and copper conductors	63
Tap connector, insulated	for insulated copper conductors	63
<b>Connector blocks</b>		
	RELICON Premium	62





### Hand cleaning tissues

#### RELICON Reliclean

RELICON Reliclean is an antibacterial, degreasing and quickly drying hand cleaning tissue. Suitable especially for workshops, industry and areas where hands and surfaces are strongly soiled. Ideal for cleaning heavily soiled hands, tools and equipment. Removes e.g. polyurethane, grease, oils, glue, bitumen, wax, soot, ink, sealants, paints, brake dust, coal dust etc.

#### Features and Benefits

- Tissue size 27 x 31 cm
- Strong one-step cleaning action
- Easily removes stubborn dirt
- Binds dirt without leaving any residue
- Reliclean restores natural oils and dries quickly
- Tissue are biodegradable
- Antibacterial, non-toxic and non-irritating
- Free of harmful substances



Cleaning cloths Reliclean.

TYPE	Pack Cont.	Article-No.
Reliclean	35 pcs.	435-01600
	70 pcs.	435-01601

All dimensions in mm. Subject to technical changes.  
Minimum Order Quantity (MOQ) may differ from package content.

### Centering sealing foam for wall feed-throughs

#### RELICON WSHEZ

The RELICON WSHEZ self-adhesive sealing foam is made for centering the WSHE heat shrinkable wall feed-throughs for building walls.

Application: For centering RELICON WSHE wall feed-through in combination with RELICON PUR DS.

#### Features and Benefits

- Material: Polyester-foam, self-adhesive
- Compressible to 90%,
- Compressive strength 2.8 -4.2 kPa (ISO 3386/1)
- Permeability: Water, gas, air
- Content: Set of sealing-foam (2 pcs), installation instructions
- Use multiple sets for larger wall feed-throughs



Self-adhesive sealing foam for wall ducts.

<b>MATERIAL</b>	Polyester (PET)
<b>Colour</b>	Grey (GY)
<b>Operating Temperature</b>	-25 °C to +80 °C
<b>Tensile Strength</b>	85 MPa



System solutions for wall ducts can be found on pages: 36, 59.



TYPE	Width (W)	Pack Cont.	Article-No.
WSHEZ	30.0	2 pcs.	435-10254

All dimensions in mm. Subject to technical changes.  
Minimum Order Quantity (MOQ) may differ from package content.

For product specific approvals please contact us under [www.HellermannTyton.com](http://www.HellermannTyton.com)



## Heat shrinkable wall for feed-throughs

### RELICON WSHE

The RELICON WSHE heat shrinkable wall feed-through is designed to protect all types of cables and conduits through building walls. It is also the perfect solution to seal against gas and moisture of conduits, wires and cables.

#### Features and Benefits

- High mechanical strength, compact dimensions, adhesive lined
- Resistant to chemicals, UV, aging and weather resistant



Heat shrinkable wall feed-through WSHE.



**System solutions for wall ducts can be found on pages: 36, 58.**

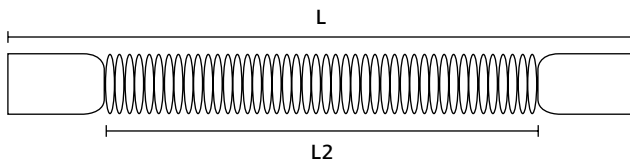

WSHE

<b>MATERIAL</b>	Polyolefin, cross-linked (PO-X)
<b>Colour</b>	Black (BK)
<b>Shrink Ratio</b>	3:1
<b>Operating Temperature</b>	-55 °C to +110 °C
<b>Minimum Shrink Temperature</b>	+120 °C



TYPE	Supplied Ø D min.	Recov. Ø d max.	Length (L)	Length (L2)	Pack Cont.	Article-No.
WSHE 14/10	14	10	800.0	500	1 pc.	435-10255
WSHE 23/12	23	12	800.0	500	1 pc.	435-10256
WSHE 28/16	28	16	800.0	500	1 pc.	435-10257
WSHE 38/20	38	20	800.0	500	1 pc.	435-10258
WSHE 48/19	48	19	800.0	500	1 pc.	435-10259
WSHE 86/45	86	45	800.0	500	1 pc.	435-10260

All dimensions in mm. Subject to technical changes.  
Minimum Order Quantity (MOQ) may differ from package content.



### Connectors

#### Compression connector, tin-plated, with central buttmark for copper conductors

Galvanised compression connectors are suitable for stranded and solid copper conductors and provided with central buttmarks for precise conductor insertion.

#### Features and Benefits

- Suitable for copper conductors
- Optimal material and compress properties because of the annealed material
- Precise end machining for easy cable insertion
- Tin-plated connector body
- With central buttmarks for precise core insertion



*Compression connector, tin-plated, with central buttmark for copper conductors*

TYPE	Inside Ø (ID)	Outside Ø (OD)	Length (L)	Pack Cont.	Article-No.
Compression connector 1.5	1.8	3.3	25.0	1 pc.	435-01450
Compression connector 2.5	2.3	4.2	25.0	1 pc.	435-01451
Compression connector 4	3	5	25.0	1 pc.	435-01452
Compression connector 6	3.5	6.5	25.0	1 pc.	435-01453
Compression connector 10	4.5	7	30.0	1 pc.	435-01454
Compression connector 16	5.5	8.5	35.0	1 pc.	435-01455
Compression connector 25	7	10	40.0	1 pc.	435-01456
Compression connector 35	8.5	12	45.0	1 pc.	435-01457
Compression connector 50	10	14	50.0	1 pc.	435-01458
Compression connector 70	12	16.5	55.0	1 pc.	435-01459
Compression connector 95	13.5	18	60.0	1 pc.	435-01460
Compression connector 120	15	19.5	65.0	1 pc.	435-01461
Compression connector 150	16.5	21	70.0	1 pc.	435-01462
Compression connector 185	19	24	75.0	1 pc.	435-01463
Compression connector 240	21	26	85.0	1 pc.	435-01464
Compression connector 300	23.5	29.5	100.0	1 pc.	435-01465
Compression connector 400	27	34	100.0	1 pc.	435-01466

All dimensions in mm. Subject to technical changes.  
Minimum Order Quantity (MOQ) may differ from package content.



## Connectors

### Mechanical connector, tin-plated, with barrier and shear-off bolts for Al and CU conductors

Galvanised mechanical connector provided with barrier and shear-off bolts. Suitable for stranded and solid aluminium and copper conductors in all kind of cable accessories. They also comply with DIN 4740 requirements for shrinking technology.

#### Features and Benefits

- For connecting different conductor cross-sections
- Suitable for aluminium and copper conductors
- Tin-plated connector body with barrier and shear-off bolts



Mechanical connectors with barrier.

TYPE	Conductor Size Range mm <sup>2</sup>	Ø D	Length (L)	Nut Size (NS)	Pack Cont.	Article-No.
Mechanical connector 1050	10 - 50	18.0	40.0	4	1 pc.	435-01503
Mechanical connector 2595	25 - 95	25.0	55.0	8	1 pc.	435-01504
Mechanical connector 2515	25 - 150	28.0	60.0	8	1 pc.	435-01505
Mechanical connector 9524	95 - 240	35.0	128.0	8	1 pc.	435-01506

All dimensions in mm. Subject to technical changes.  
Minimum Order Quantity (MOQ) may differ from package content.

## Connectors

### Mechanical connector, tin-plated, with blind hole for Al and CU conductors

Galvanised mechanical connector provided with a blind hole and suitable for stranded and solid aluminium and copper conductors in all kind of cable accessories. They also comply with DIN 4740 requirements for shrinking technology.

#### Features and Benefits

- For connecting different conductor cross-sections
- Suitable for aluminium and copper conductors
- With blind hole for precise conductor insertion
- Tin-plated connector body and hexagon socket screws



Mechanical connectors without barrier.

TYPE	Conductor Size Range mm <sup>2</sup>	Ø D	Length (L)	Nut Size (NS)	Pack Cont.	Article-No.
Mechanical connector 1506	1.5 - 6	7.0	-	1.5	1 pc.	435-01500
Mechanical connector 1516	1.5 - 16	10.0	30.0	2.5	1 pc.	435-01501
Mechanical connector 635	6 - 35	14.0	40.0	4	1 pc.	435-01502

All dimensions in mm. Subject to technical changes.  
Minimum Order Quantity (MOQ) may differ from package content.



### Connector blocks

#### RELICON Premium

The connector block is made of transparent polymeric material and assembled with 5 mechanical connectors inside. An allen key is included. The three different sizes are adapted to the right core cross sections and spaces that are needed for each joint. All connectors are suitable for aluminium and copper conductors as well. This makes the connection reliable and easy.

#### Features and Benefits

- Transparent, polymeric material
- 5 mechanical connectors including allen key
- 3 sizes available
- For Al and Cu conductors



SV-Connector blocks.

TYPE	Conductor Size Range mm <sup>2</sup>	Article-No.
SV1	1.5 - 6	435-01400
SV2	1.5 - 16	435-01401
SV3	6 - 35	435-01402

All dimensions in mm. Subject to technical changes.  
Minimum Order Quantity (MOQ) may differ from package content.

### Connectors

#### Tap connector, uninsulated, for copper conductors

Bright finished tap connector for screwing stranded and solid copper conductors according to VDE 0295 Class 1 and 2.

#### Features and Benefits

- For connecting conductors to VDE 0295 Class 1 and 2
- One bolt type, bright finished, uninsulated



Tap connectors, uninsulated, for copper conductors.

TYPE	Conductor Size Range mm <sup>2</sup>	Length (L)	Width (W)	Mounting Screw Type	Pack Cont.	Article-No.
Tap connector 2516	2.5 - 16	16.0	19.5	M5	1 pc.	435-01550
Tap connector 2525	2.5-25.0	18.0	25.0	M6	1 pc.	435-01551
Tap connector 6035	6.0-35.0	20.0	28.0	M7	1 pc.	435-01552
Tap connector 6050	6.0-50.0	24.0	32.5	M7	1 pc.	435-01553
Tap connector 10070	10.0-70.0	24.0	37.5	M8	1 pc.	435-01554
Tap connector 25095	25.0-95.0	31.0	45.0	M10	1 pc.	435-01555

All dimensions in mm. Subject to technical changes.  
Minimum Order Quantity (MOQ) may differ from package content.

For product specific approvals please contact us under [www.HellermannTyton.com](http://www.HellermannTyton.com)





## Connectors

### Tap connector, insulated, for insulated aluminium and copper conductors

Insulated tap connector for screwing stranded and solid insulated aluminium and copper conductors.

#### Features and Benefits

- Suitable for insulated aluminium and copper conductors
- One bolt type, insulated



Tap connector, insulated, for copper and aluminium conductors.

TYPE	Conductor Size Range mm <sup>2</sup>	Width (W)	Mounting Screw Type	Pack Cont.	Article-No.
Tap connector 1516	1.5-16.0	26.0	M6	1 pc.	435-01557

All dimensions in mm. Subject to technical changes.  
Minimum Order Quantity (MOQ) may differ from package content.

## Connectors

### Tap connector, insulated, for insulated copper conductors

Insulated tap connector for screwing stranded and solid insulated copper conductors.

#### Features and Benefits

- Suitable for insulated copper conductors
- One bolt type, insulated



Tap connector, insulated, for copper conductors.

TYPE	Conductor Size Range mm <sup>2</sup>	Width (W)	Mounting Screw Type	Pack Cont.	Article-No.
Tap connector 1510	1.5-10.0	23.0	M5	1 pc.	435-01556

All dimensions in mm. Subject to technical changes.  
Minimum Order Quantity (MOQ) may differ from package content.



A large grid of small dots for taking notes, consisting of approximately 30 columns and 40 rows.



A large grid of small dots for taking notes, consisting of approximately 30 columns and 40 rows.

## Expertise worldwide

You will find your local contact here:

### Europe

 **HellermannTyton GmbH – Austria**  
Rennbahnweg 65  
1220 Vienna  
Tel.: +43 12 59 99 55-0  
Fax: +43 12 59 99 11  
Email: office@HellermannTyton.at  
www.HellermannTyton.at

 **HellermannTyton – Czech Republic**  
Email: officeCZ@HellermannTyton.at  
www.HellermannTyton.cz

 **HellermannTyton – Denmark**  
Industrivej 44A, 1.  
4000 Roskilde  
Tel.: +45 702 371 20  
Fax: +45 702 371 21  
Email: htdk@HellermannTyton.dk  
www.HellermannTyton.dk

 **HellermannTyton – Finland**  
Sähkötie 8  
01510 Vantaa  
Tel.: +358 9 8700 450  
Fax: +358 9 8700 4520  
Email: myynti@HellermannTyton.fi  
www.HellermannTyton.fi

 **HellermannTyton S.A.S. – France**  
2 rue des Hétries - CS 80543  
78197 Trappes Cedex  
Tel.: +33 1 30 13 80 00  
Fax: +33 1 30 13 80 60  
Email: info@HellermannTyton.fr  
www.HellermannTyton.fr

 **HellermannTyton GmbH – Germany**  
Großer Moorweg 45  
25436 Tornesch  
Tel.: +49 4122 701-0  
Fax: +49 4122 701-400  
Email: info@HellermannTyton.de  
www.HellermannTyton.de

 **HellermannTyton KFT – Hungary**  
Kisfaludy u. 13  
1044 Budapest  
Tel.: +36 1 369 4151  
Fax: +36 1 369 4151  
Email: officeHU@HellermannTyton.at  
www.HellermannTyton.hu

 **HellermannTyton Ltd – Ireland**  
Unit 77 Cherry Orchard  
Industrial Estate  
Ballyfermot, Dublin 10  
Tel.: +353 1 626 8267  
Fax: +353 1 626 8022  
Email: sales@HellermannTyton.ie  
www.HellermannTyton.co.uk

 **HellermannTyton S.r.l. – Italy**  
Via Visco, 3/5  
35010 Limena (PD)  
Tel.: +39 049 767 870  
Fax: +39 049 767 985  
Email: info@HellermannTyton.it  
www.HellermannTyton.it

 **HellermannTyton B.V. – Belgium/Netherlands**  
Vanadiumweg 11-C  
3812 PX Amersfoort  
Tel.: +31 33 460 06 90  
Fax: +31 33 460 06 99  
Email (NL): info@HellermannTyton.nl  
Email (BE): info@HellermannTyton.be  
www.HellermannTyton.nl  
www.HellermannTyton.be

 **HellermannTyton AS – Norway**  
PO Box 240 Alnabru  
0614 Oslo  
Tel.: +47 23 17 47 00  
Fax: +47 22 97 09 70  
Email: firmapost@HellermannTyton.no  
www.HellermannTyton.no

 **HellermannTyton Sp. z o.o. – Poland**  
ul. Berdychów 57A  
62-410 Zagórow  
Tel.: +48 63 2401 849  
Fax: +48 63 2401 848  
Email: info@HellermannTyton.pl  
www.HellermannTyton.pl

 **HellermannTyton – Romania**  
Email: officeRO@HellermannTyton.at  
www.HellermannTyton.at

 **OOO HellermannTyton – Russia**  
40/4, Pulkovskoe road  
BC Technopolis Pulkovo, office A 8081  
196158, St. Petersburg  
Tel.: +7 812 386 00 09  
Fax: +7 812 386 00 08  
Email: info@HellermannTyton.ru  
www.HellermannTyton.ru

 **HellermannTyton – Slovenia**  
Branch Office Ljubljana  
Podružnica Ljubljana, Leskoškova 6  
1000 Ljubljana  
Tel.: +386 1 433 70 56  
Fax: +386 1 433 63 21  
Email: officeSI@HellermannTyton.at  
www.HellermannTyton.si

 **HellermannTyton España s.l. – Spain/Portugal**  
Avda. de la Industria 37 2 2  
28108 Alcobendas, Madrid  
Tel.: +34 91 661 2835  
Fax: +34 91 661 2368  
Email:  
HellermannTyton@HellermannTyton.es  
www.HellermannTyton.es

 **HellermannTyton AB – Sweden**  
Isafjordsgatan 5  
16440 Kista  
Tel.: +46 8 580 890 00  
Fax: +46 8 580 348 02  
Email: support@HellermannTyton.se  
www.HellermannTyton.se

 **HellermannTyton Engineering GmbH – Turkey**  
Saray Mah Dr. Adnan Büyükdeleniz Cad. No:4  
Akkom Office Park 2. Blok Kat: 10  
34768 Ümraniye-Istanbul  
Tel.: +90 216 687 03 40  
Fax: +90 216 250 32 32  
Email: info@HellermannTyton.com.tr  
www.HellermannTyton.com.tr

 **HellermannTyton Ltd – UK**  
William Prance Road  
Plymouth International Medical  
and Technology Park  
Plymouth, Devon PL6 5WR  
Tel.: +44 1752 701 261  
Fax: +44 1752 790 058  
Email: info@HellermannTyton.co.uk  
www.HellermannTyton.co.uk

 **HellermannTyton Ltd – UK**  
Sharston Green Business Park  
1 Robeson Way  
Altrincham Road, Wythenshawe  
Manchester M22 4TY  
Tel.: +44 161 947 2200  
Fax: +44 161 947 2220  
Email: sales@HellermannTyton.co.uk  
www.HellermannTyton.co.uk

 **HellermannTyton Ltd – UK**  
Cley Road  
Kingswood Lakeside  
Cannock, Staffs  
WS11 8AA  
Tel.: +44 1922 458 151  
Fax: +44 1922 743 053  
Email: info@HellermannTyton.co.uk  
www.HellermannTyton.co.uk

 **HellermannTyton Data Ltd – UK**  
Cornwell Business Park  
43-45 Salthouse Road, Brackmills  
Northampton NN4 7EX  
Tel.: +44 1604 707 420  
Fax: +44 1604 705 454  
Email: sales@htdata.co.uk  
www.htdata.co.uk

### Middle East

 **HellermannTyton – UAE**  
Email: info@HellermannTyton.ae  
www.HellermannTyton.ae

### North America

 **HellermannTyton – Canada**  
Tel.: +1 905 726 1221  
Fax: +1 905 726 8538  
Email: sales@HellermannTyton.ca  
www.HellermannTyton.ca

 **HellermannTyton – Mexico**  
Tel.: +52 333 133 9880  
Fax: +52 333 133 9861  
Email: info@HellermannTyton.com.mx  
www.HellermannTyton.com

 **HellermannTyton – USA**  
Tel.: +1 414 355 1130  
Fax: +1 414 355 7341  
Email: corp@htamericas.com  
www.HellermannTyton.com

### South America

 **HellermannTyton – Argentina**  
Tel.: +54 11 4754 5400  
Fax: +54 11 4752 0374  
Email: ventas@HellermannTyton.com.ar  
www.HellermannTyton.com.ar

 **HellermannTyton – Brazil**  
Tel.: +55 11 4815 9000  
Fax: +55 11 4815 9030  
Email: vendas@HellermannTyton.com.br  
www.HellermannTyton.com.br

### Asia-Pacific

 **HellermannTyton – Australia**  
Tel.: +61 2 9525 2133  
Fax: +61 2 9526 2495  
Email: cservice@HellermannTyton.com.au  
www.HellermannTyton.com.au

 **HellermannTyton – China**  
Tel.: +86 510 8528 2536  
Fax: +86 510 8528 2731  
Email: cservice@HellermannTyton.com.cn  
www.HellermannTyton.com.cn

 **HellermannTyton – Hong Kong**  
Tel.: +852 2832 9090  
Fax: +852 2832 9381  
Email: cservice@HellermannTyton.com.hk  
www.HellermannTyton.com.sg

 **HellermannTyton – India**  
Tel.: +91 120 413 3384  
Bangalore: +91 776 001 0104  
Chennai: +91 996 264 3939  
Faridabad: +91 971 851 7797  
Ghaziabad: +91 93 1354 1671  
Pune: +91 727 601 2200  
Email: cservice@HellermannTyton.co.in  
www.HellermannTyton.co.in

 **HellermannTyton – Japan**  
Tel.: +81 3 5790 3111  
Fax: +81 3 5790 3112  
Email: mkt@hellermannnyton.co.jp  
www.HellermannTyton.co.jp

 **HellermannTyton – Republic of Korea**  
Tel.: +82 31 388 8012  
Fax: +82 31 388 8013  
Email: cservice@HellermannTyton.co.kr  
www.HellermannTyton.co.kr

 **HellermannTyton – Philippines**  
Tel.: +63 2 752 6551  
Fax: +63 2 752 6553  
Email: cservice@HellermannTyton.com.ph  
www.HellermannTyton.com.ph

 **HellermannTyton – Singapore**  
Tel.: +65 6 586 1919  
Fax: +65 6 752 2527  
Email: cservice@HellermannTyton.sg  
www.HellermannTyton.com.sg

 **HellermannTyton – Thailand**  
Tel.: +662 237 6702 / 266 0624  
Fax: +662 266 8664  
Email: cservice@HellermannTyton.co.th  
www.HellermannTyton.com.sg

### Africa

 **HellermannTyton – South Africa**  
Tel.: +27 11 879 6680  
Fax: +27 11 879 6601  
Email: sales.jhb@Hellermann.com.za  
www.HellermannTyton.com.za

Wherever you need us –  
we are there for you



If you are looking for a local information,  
please visit our website  
[www.HellermannTyton.com](http://www.HellermannTyton.com)

Choose your country and you will be directed to the respective  
HellermannTyton company.





**RELICON** by  
**HellermannTyton**  
[www.HellermannTyton.com](http://www.HellermannTyton.com)

10/2016 031-93417  
CAT RELICON