



Rail vehicle construction

You put great ideas on rails.
We take care of the details.

*HellermannTyton – Competence in
rail vehicle construction*

HellermannTyton



There is hardly any other industry sector that puts such high demands on components and solutions as modern rail vehicle construction. The highest quality, maximum service life and compliance with the strictest safety criteria are absolute requirements.

More than 20,000 products, many years of **industry know-how** and a high degree of **development competence** make HellermannTyton one of the leading companies for sophisticated solutions in bundling, fastening, identifying, protecting and processing cables and lines in rail vehicle construction.



You put things in motion.
We ensure support.

Our industry expertise



We develop **product solutions for the future**. This requires not only visionary thinking, but also the goal of always being in tune with our customers' requests. We achieve this by maintaining a close dialogue with our customers and through motivated employees who know that teamwork pays off. In our view, to be satisfied with the best solution, you need **professionals who put forward-looking thinking and personnel commitment ahead of everything else**. This applies both internally as well as in the development process with our customers.

The results are product solutions that shape the market in many ways and make the highest worldwide quality standards the norm.

Our years of experience in collaboration with well-known manufacturers and suppliers in rail vehicle construction, our high degree of specialisation and our wide-ranging technical know-how make **our products into the best solution for you**.



Rail vehicle construction places high demands on all products that are used here. Innovative solutions made of high-quality raw materials, excellent fire protection properties and a long service life characterise the extensive product range of HellermannTyton for this industry.

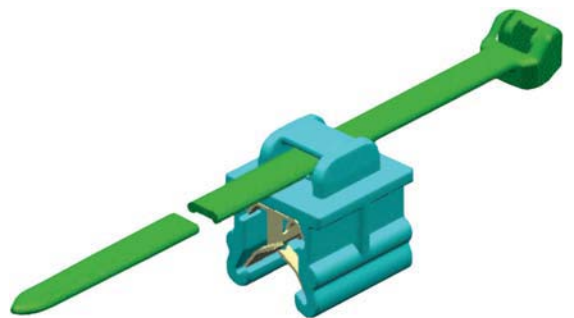

Tangible support from virtual reality: the digital test model of an EdgeClip.

You have high requirements.
We have the best products to meet them.

Our quality awareness

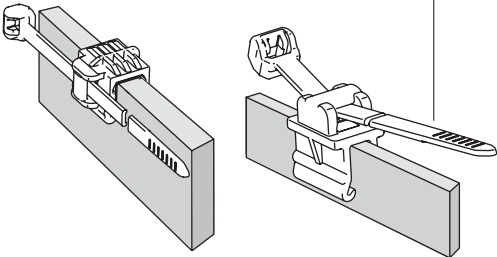

The "EdgeClip" product family is a time-saving and innovative alternative to the tried and tested cable cross-over application.



TF21 green-yellow provides lasting protection for cable lugs and clearly indicates the earthing cables.



The MBT metal tie with a patented, non-releasable locking feature is made of stainless steel. It can thus certainly stand up to heat, acids and salt water.



Popular: Cross-over applications with cable ties.

Each one of our customers presents us with very specific challenges. In rail vehicle construction, particular attention is paid to **safety, quality** and a **long service life**.

Safety is of utmost importance anywhere where public transport is involved. Therefore, all components used in rail vehicle construction must minimise, or better still eliminate potential danger to passengers, even in extreme cases.

Naturally, the products from HellermannTyton meet the highest demands in this regard and have industry-relevant certifications.

Specifically, this means the following: Our products for rail vehicle construction have **excellent fire protection properties**. Regarding flammability, development of smoke and toxicity, they meet the strictest safety requirements so that they will not be the cause of hazards in the event of a fire.

Longevity is another decisive criterion. With us, you can depend on all products having an above-average service life, even under high loads.

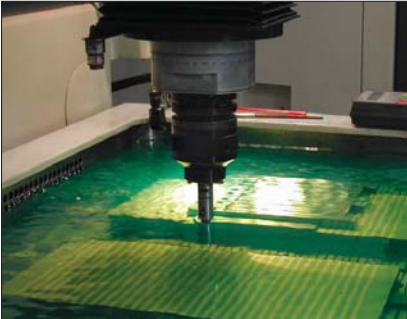

Innovation that works for our customers: is achieved by our company's own mould tool manufacture and production moulding processes.

With HellermannTyton, you can rely on a high level of quality worldwide for the materials and workmanship.

The use of the highest-quality raw materials, **our company's own tool and mould making** as well as our own quality inspection create optimum production conditions.

Moreover, all products are constantly scrutinised and optimised by our **worldwide network of developers**. That makes us into a reliable partner for you, **today and in the future**.





Always find just the right item! The HellermannTyton main catalogue.

Finding just the right item from more than 20,000 products is very easy with the new HellermannTyton main catalogue. The clear colour coding, self-explanatory symbols and an overview that can be folded out, guide you quickly to the product you are looking for.



The entire product range of **manual and pneumatic processing tools** for flush-cut cable tie bundling can be found clearly grouped in our main catalogue.

Are you looking for the right solution?
We have it – quickly, easily and individually.

Our product range

Intensive analyses of the market and the competition make it possible for us to recognise processing and market trends at an early stage. The current result: more than 20,000 individual products that are always from state-of-the-art research and development which set worldwide standards.

Besides the unique diversity of products, we offer individually designed solutions specifically for your needs in rail vehicle construction. **Our team of experts is happy to help out at any time.**

In the **supply chain**, you also have all the advantages on your side with HellermannTyton. You obtain **all products from a single source**, reduce the number of suppliers, and that way have considerable savings potential in the procurement costs. Our tightly meshed network of branch offices and distribution partners around the world ensures that you have a constantly **high level of service, high flexibility** as well as **fast response and delivery times**.

Cable ties and fastening systems

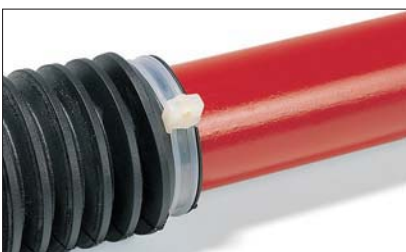

The patented **KR tie** provides a secure hold even in high-vibration systems such as vibration dampers, for example.



The **2-way holder** ensures a defined distance between two bundles, such as for separate installation of different voltage levels, for example.



EdgeClips and **cable ties** combined together, result in perfect fastening without drilling holes or using glue, and are therefore ideally suited to reducing extra parts and time to fit.



Cable ties with fire protection class UL94 V0 are made of halogen-free and very quickly self-extinguishing materials. They are thus very well suited for fire protection requirements in passenger trains, commuter trains, and underground railways.



The rustproof **MBT stainless steel ties** resist acids and high temperature. They are available both coated and uncoated. Their patented, non-releasable locking mechanism is a major safety feature.

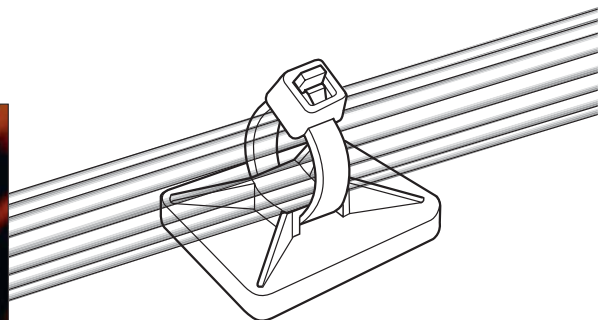

MB mounts for equipment cabinet construction are fastened by gluing or screwing and make it possible to thread in the cable ties from all 4 directions.



Heat-shrink products 



The right-angled, moulded, heat-shrinkable parts of the **Helashrink Series 1100** provide strain relief and high physical protection for connector-cable connections with circular connectors.



The transparent **TF24** tubing ensures protection against physical and electrical effects and is primarily used in identification solutions.



Cables can be safely inserted into the equipment cabinet module. A **ShrinkTrak heat-shrinkable tubing marker** is used for labelling.



The flexible heat-shrinkable tubing **TF21** has very good physical and chemical properties, and can be easily imprinted for identification purposes.



The thin-walled **TR27** heat-shrinkable tubing is halogen-free, self-extinguishing and thus extremely suitable for installation in tunnels.

The **HFT-A** heat-shrinkable tubing is used for physical and electrical protection of components and can be used for colour identification.





Our product range



Cable protection 



HEGP and **HEGPX** are flexible, easy to pull on braided sleeves. An optimum fit and good abrasion resistance guarantee a high level of cable protection.



The flame retardant **HelaGuard PA6** protective sleeve is ideal for high fire protection requirements, like in trains for example. It is very flexible, abrasion resistant and dimensionally stable.



With the closely fitting, shaped track of the **Flexiform** edge protector, you obtain optically clean and mechanically safe protection of cables and lines at plate edges.

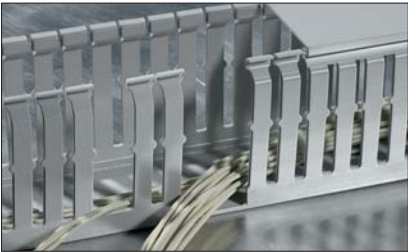

The halogen-free wiring duct **HTWD-HF** meets the common fire protection standards of rail vehicle construction and is well suited for use in the vehicle.



The **Helawrap HWPV-V0** cable management system for bundling and protecting lines is the optimum choice if fire retarding properties are required.



The **HelaGuard 90°** fitting with the swivelling brass external thread complies with protection class IP69K.

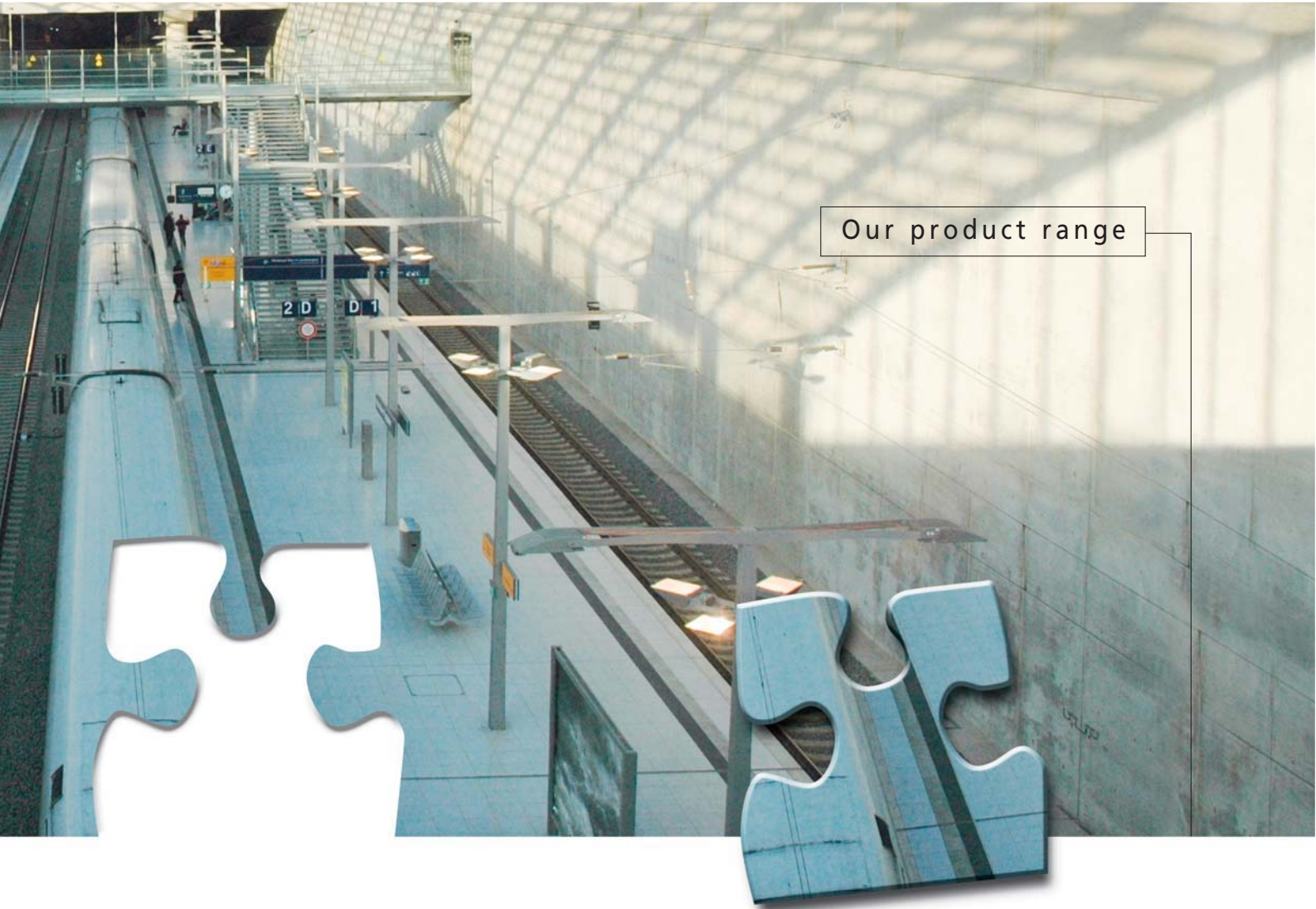

Our product range

Identification systems 



Halogen-free **TIPTAG tags** are suitable for marking large cable diameters. They are used with high fire protection requirements in tunnel construction.



The halogen-free identification tubing **TLFX** is suitable above all for markings in vehicle wiring and equipment cabinets due to the low propagation of smoke and gas in the event of a fire.



It is possible to easily print labels and heat-shrink tubes with the **thermal transfer printer TT 4000+**.



The **M-BOSS stainless steel markings** remain stable and easily readable even under extreme weather conditions like in signalling systems. They are processed with the M-BOSS embossing machine.



The entry level model **TT420** with a print head resolution of 203 dpi can handle different types of labels and heat-shrinkable markers.



The thermal transfer printer **TrakMark DS** can print the front and back of a section of heat-shrinkable tubing in only one operation.

So that you don't compromise on safety,
we set standards that are certified.

For you, safety is the top priority. With certified products from HellermannTyton, you can always rely on safety. In addition, our strict quality assurance guarantees the highest standards.

DIN 5510-2

DIN 5659-2
DIN 54837
DIN 53548

LUL E1042

NF F 00-608

EN ISO 4589-1, -2

NF F 16-101, -102

NF X 70-100-1
NF X 10-702

EN 60695-2

If you have any questions on specific problem solutions or would you like to have more information, we would be happy to help – with all our experience and with technical know-how.

Europe
Frank Heinze

f.heinze@HellermannTyton.de
+49 (0) 3843 82281

Netherlands/Belgium
Raymond Nierkes

railindustrie@HellermannTyton.nl
+31 (0) 33 460 06 90

Germany
Frank Heinze

f.heinze@HellermannTyton.de
+49 (0) 3843 82281

United Kingdom
Kevin Bunfield

kevin.bunfield@HellermannTyton.co.uk
+44 (0) 7980 873 367

France
Jacques Hannover

jhannoyer@HellermannTyton.fr
+33 (0) 6 72 88 92 82

Italy
Marco Benato

ferroviario@HellermannTyton.it
+39 049 767 870

Austria/Eastern Europe
Heinz Jenner

heinz.jenner@HellermannTyton.at
+43 (0) 1 259 99 55-0

Spain
David Martinez

david.martinez@HellermannTyton.es
+34 (0) 657 97 22 49

www.HellermannTyton.com

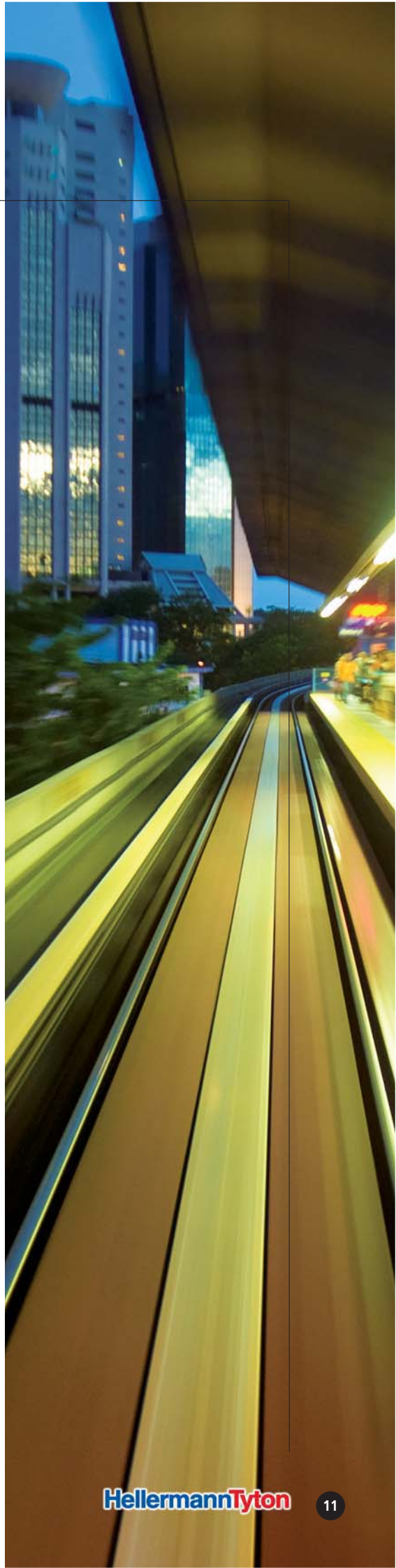

We are there where you need us.

Our network of contact persons ensures that we are there for you worldwide. You can therefore rely on our quick response times and reliability in sales and service.

Europe

HellermannTyton GmbH – Austria
Obachgasse 6
1221 Vienna
Tel: +43 12 59 99 55
Fax: +43 12 59 99 11
E-Mail: office@HellermannTyton.at
www.HellermannTyton.at

HellermannTyton – Czech Republic
E-Mail: office.cz@HellermannTyton.at
www.HellermannTyton.cz

HellermannTyton AB – Denmark
Baldersbuen 15D 1. TV
2640 Hedehusene
Tel: +45 702 371 20
Fax: +45 702 371 21
E-Mail: htdk@HellermannTyton.dk
www.HellermannTyton.dk

HellermannTyton Oy – Finland
Sähkötie 8
01510 Vantaa
Tel: +358 9 8700 450
Fax: +358 9 8700 4520
E-Mail: myynti@HellermannTyton.fi
www.HellermannTyton.fi

HellermannTyton S.A.S. – France
2 rue des Hêtres, B.P. 130
78196 Trappes Cedex
Tel: +33 1 30 13 80 00
Fax: +33 1 30 13 80 60
E-Mail: info@HellermannTyton.fr
www.HellermannTyton.fr

HellermannTyton GmbH – Germany
Großer Moorweg 45
25436 Tornesch
Tel: +49 4122 701-0
Fax: +49 4122 701-400
E-Mail: info@HellermannTyton.de
www.HellermannTyton.de

HellermannTyton KFT – Hungary
Kisfaludy u. 13
1044 Budapest
Tel: +36 1 369 4151
Fax: +36 1 369 4151
E-Mail: office@HellermannTyton.hu
www.HellermannTyton.hu

HellermannTyton S.r.l. – Italy
Via Praimbole 9 Bis
35010 Limena (PD)
Tel: +39 049 767 870
Fax: +39 049 767 985
E-Mail: info@HellermannTyton.it
www.HellermannTyton.it

HellermannTyton Ltd – Ireland
Unit 77 Cherry Orchard
Industrial Estate
Ballyfermot, Dublin 10
Tel: +353 1 626 8267
Fax: +353 1 626 8022
E-Mail: sales@HellermannTyton.ie
www.HellermannTyton.co.uk

HellermannTyton B.V. – Netherlands
Vanadiumweg 11-C
3812 PX Amersfoort
Tel: +31 33 460 06 90
Fax: +31 33 460 06 99
E-Mail: info@HellermannTyton.nl
www.HellermannTyton.nl

HellermannTyton AS – Norway
PO Box 240 Alnabru
0614 Oslo
Tel: +47 23 17 47 00
Fax: +47 22 97 09 70
E-Mail: firmapost@HellermannTyton.no
www.HellermannTyton.no

HellermannTyton – Poland
E-Mail: info@HellermannTyton.pl
www.HellermannTyton.pl

OOO HellermannTyton – Russia
St. Petersburg
E-Mail: info@HellermannTyton.ru
www.HellermannTyton.ru

HellermannTyton – Slovenia
Branch Office Ljubljana
Trubarjeva 79
1101 Ljubljana
Tel: +386 1 433 70 56
Fax: +386 1 433 63 21
E-Mail: sales@HellermannTyton.si
www.HellermannTyton.si

HellermannTyton España s.l. – Spain/Portugal
Avda. de la Industria nº 37, 2º 2º
28.108 Alcobendas, Madrid
Tel: +34 91 661 2835
Fax: +34 91 661 2368
E-Mail:
HellermannTyton@HellermannTyton.es
www.HellermannTyton.es

HellermannTyton AB – Sweden
Datavägen 5, PO Box 569
17526 Järfälla
Tel: +46 8 580 890 00
Fax: +46 8 580 890 01
E-Mail: support@HellermannTyton.se
www.HellermannTyton.se

HellermannTyton Ltd – UK
Manufacturing Site
Pennycross Close, Plymouth
Devon PL2 3NX
Tel: +44 1752 701 261
Fax: +44 1752 790 058
E-Mail: info@HellermannTyton.co.uk
www.HellermannTyton.co.uk

HellermannTyton Ltd – UK
Manufacturing Site
Sharston Green Business Park
1 Robeson Way
Altrincham Road, Wythenshawe
Manchester M22 4TY
Tel: +44 161 945 4181
Fax: +44 161 945 3708
E-Mail: info@HellermannTyton.co.uk
www.HellermannTyton.co.uk

HellermannTyton Ltd – UK
Main Contact for Customer Service
Wharf Approach
Aldridge, Walsall, West Midlands
W9 8BX
Tel: +44 1922 458 151
Fax: +44 1922 743 237
E-Mail: info@HellermannTyton.co.uk
www.HellermannTyton.co.uk

HellermannTyton Data Ltd – UK
43–45 Salthouse Road
Cornwell Business Park Brackmills
Northampton NN4 7EX
Tel: +44 1604 707 420
Fax: +44 1604 705 454
E-Mail: hns@htdata.co.uk
www.htdata.co.uk

North America

HellermannTyton – Canada
Tel: +1 905 726 1221
Fax: +1 905 726 8538
E-Mail: sales@HellermannTyton.ca
www.HellermannTyton.ca

HellermannTyton – Mexico
Tel: +52 333 133 9880
Fax: +52 333 133 9861
E-Mail: info@HellermannTyton.com.mx
www.HellermannTyton.com

HellermannTyton – USA
Tel: +1 414 355 1130
Fax: +1 414 355 7341
E-Mail: corp@htamericas.com
www.HellermannTyton.com

South America

HellermannTyton – Argentina
Tel: +54 11 4754 5400
Fax: +54 11 4752 0374
E-Mail: ventas@HellermannTyton.com.ar
www.HellermannTyton.com.ar

HellermannTyton – Brazil
Tel: +55 11 4815 9000
Fax: +55 11 4815 9030
E-Mail: vendas@HellermannTyton.com.br
www.HellermannTyton.com.br

Asia-Pacific

HellermannTyton – Australia
Tel: +61 2 9525 2133
Fax: +61 2 9526 2495
E-Mail: cservice@HellermannTyton.com.au
www.HellermannTyton.com.au

HellermannTyton – China
Tel: +86 510 528 2536
Fax: +86 510 528 0112
E-Mail: cservice@HellermannTyton.com.cn
www.HellermannTyton.com.cn

HellermannTyton – Hong Kong
Tel: +852 2832 9090
Fax: +852 2832 9381
E-Mail: cservice@HellermannTyton.com.hk
www.HellermannTyton.com.sg

HellermannTyton – India
Tel: +91 11-2620 9230/6661 9230
Fax: +91 11-2620 9330/6661 9330
E-Mail: cservice@HellermannTyton.co.in
www.HellermannTyton.co.in

HellermannTyton – Japan
Tel: +81 3 5790 3111
Fax: +81 3 5790 3112
E-Mail: cservice@HellermannTyton.co.jp
www.HellermannTyton.co.jp

HellermannTyton – Korea
Tel: +82 2 2614 0157
Fax: +82 2 2614 0284
E-Mail: cservice@HellermannTyton.co.kr
www.HellermannTyton.co.kr

HellermannTyton – Philippines
Tel: +63 2 752 6551
Fax: +63 2 752 6553
E-Mail: cservice@HellermannTyton.com.ph
www.HellermannTyton.com.ph

HellermannTyton – Singapore
Tel: +65 6 852 8585
Fax: +65 6 756 6798
E-Mail: cservice@HellermannTyton.sg
www.HellermannTyton.com.sg

HellermannTyton – Thailand
Tel: +66 2 237 6702
Fax: +66 2 266 8664
E-Mail: cservice@HellermannTyton.com.th
www.HellermannTyton.com.sg

Africa

HellermannTyton – South Africa
Tel: +27 11 879 6680
Fax: +27 11 879 6601
E-Mail: sales.jhb@Hellermann.co.za
www.HellermannTyton.co.za

HellermannTyton

www.HellermannTyton.com