

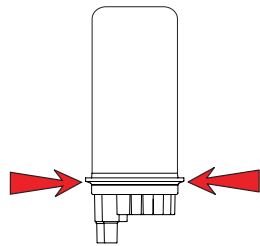

## FDN Closure Base Installation Manual

- Manuel d'installation de l'Embase FDN
- FDN Base - Installationsanleitung
- Installationsanvisning FDN
- Manual de instalación de la Base del FDN
- Manual de Instalação da Base do FDN
- Manuale d'installazione per la base FDN
- FDN Base Telepítési útmutató
- Baza FDN - instrucțiuni de instalare
- FDN Základní návod k obsluze
- Installasjonsanvisning FDN
- FDN Osnovna Navodila za montažo
- Installatie instructie voor FDN basis

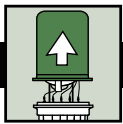

①

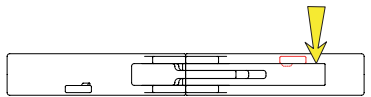

②

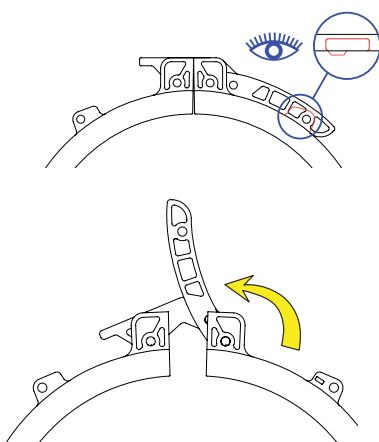

③

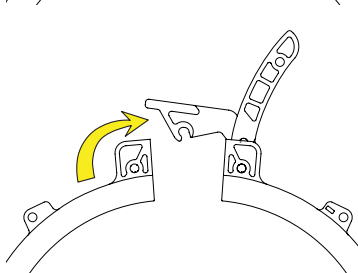

Port	Number of Ports	Cablelok™		Heatsrink	
		≥ Ø (mm)	≤ Ø (mm)	≥ Ø (mm)	≤ Ø (mm)
L	1	2 x 5.5	20.0	2 x 10.0	24.0
T	2	15.5	29.0	8.0	35.0
S	4	5.0	20.0	12.0	26.0
B	2	4.8	16.5	6.0	19.0
R	52	1.7	9.5	-	-

**Port** - port - Anschluß - Port - puerto - porto - porta - Port - Port - Port - Racord - port - poort

**Number of Ports** - Nombre de ports - Anzahl der Anschlüsse - Antal portar - Número de puertos - Número de portos - Numero di porte - Portok száma - Numar racorduri - Počet portů - Antall porter - Števílo portov - Aantal poorten

**Heatsrink** - Thermo rétractable - Wärmeschrumpfschlauch - Krymslang - Termoretráctil - Termorretráteis - Termorestringente - Zsugorcső - Termocontractibil - Teplem smršťitelné hadice - krympestrømpe - toploskrča cev - Krimpkouss

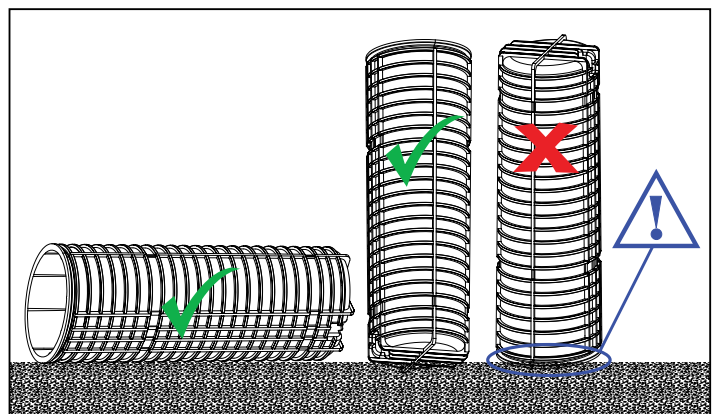
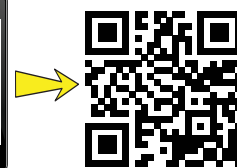

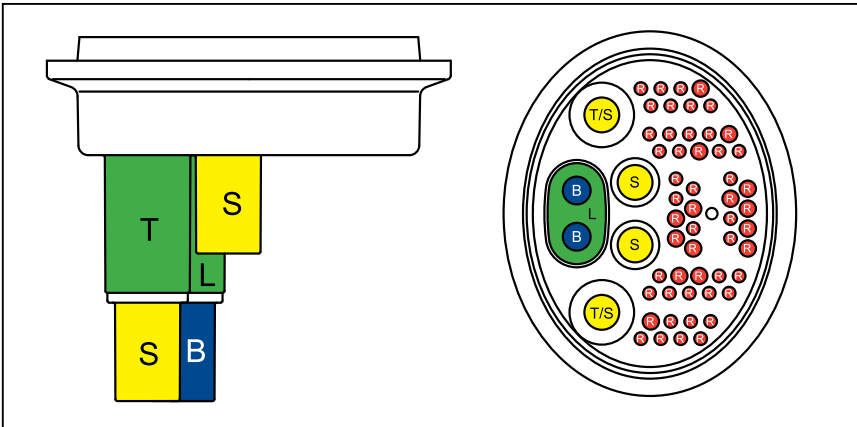
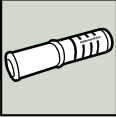

Ø (mm)	Cablelok™
1.7 - 2.0	R10
2 x 1.7 - 2.0	R10D
2.0 - 3.0	R15
3.0 - 3.8	R20
2 x 3.8 - 4.8	R30D
3.8 - 5.2	R40
5.2 - 8.0	R50
6.0 - 8.5	R70
8.0 - 9.5	R80

Ø (mm)	Cablelok™
4.8 - 9.0	B10
8.0 - 14.0	B20
13.0 - 16.5	B30

Ø (mm)	Cablelok™
5.0 - 8.5	S10
8.0 - 12.0	S20
2 x 10.0 - 11.5	S30D
12.0 - 16.0	S40
16.0 - 20.0	S50

Ø (mm)	Cablelok™
2 x 5.5 - 9.5	L10C
2 x 9.0 - 12.5	L20C
2 x 12.0 - 15.0	L30C
2 x 15.0 - 18.5	L40C
2 x 18.3 - 20.0	L50C

Ø (mm)	Cablelok™
15.5 - 22.0	T10
20 - 23.5	T20
23.5 - 25.5	T30
24.5 - 29.0	T40

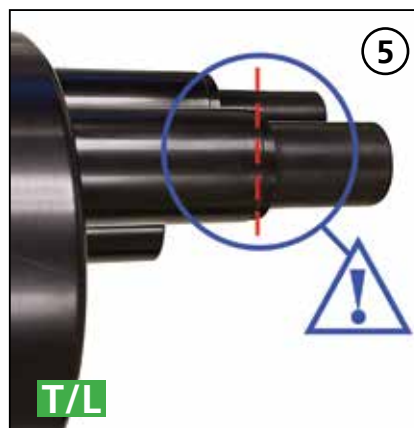



### 1 Cablelok Loop

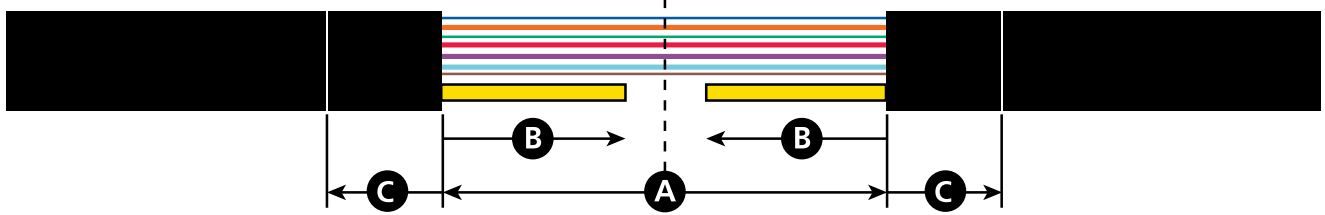

### 2 Cablelok

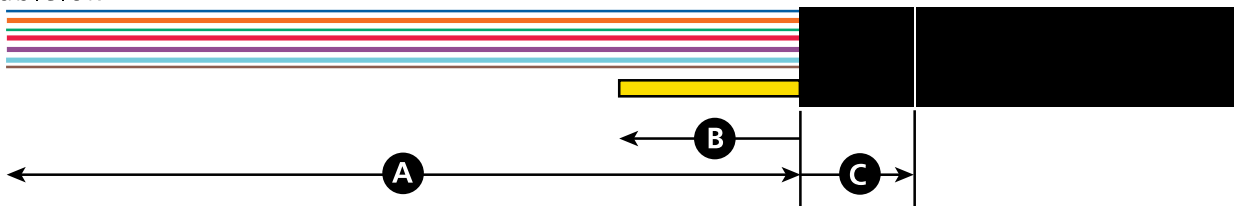

### 3 Heatshrink Loop

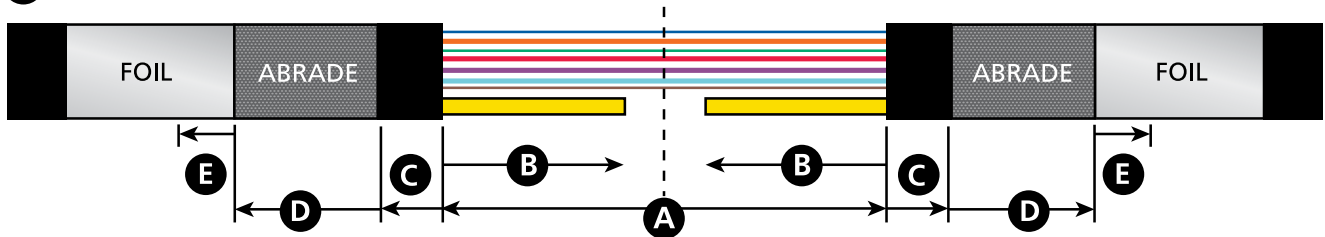

### 4 Heatshrink

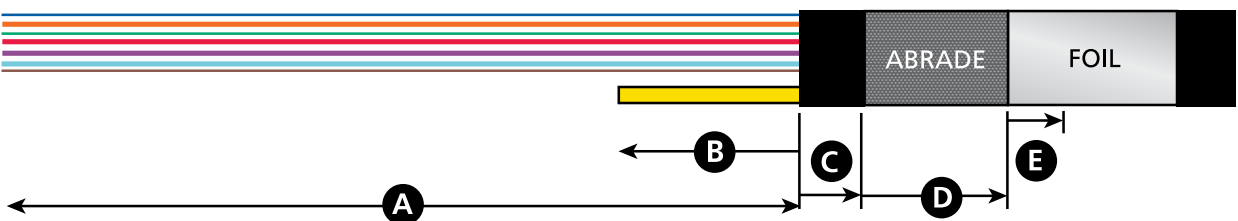

	A	B	C	D	E
1	4000mm	150mm	50mm	-	-
2	2500mm	150mm	50mm	-	-
3	4000mm	150mm	20mm	130mm	20mm
4	2500mm	150mm	20mm	130mm	20mm

**Abrade** - Afschuren - Slipa - Abradar - Desgastar - Abradere - Poncer - Pobrusite - Obrousit - Ledörzsöl - Şlefui - Obrúšit' - Abschürfen - Slipes - Hiertää - Slib  
**Foil** - Foelie - Folie - FLorete - Papel De Aluminio - Foil - Foil - Folije - Fólie - Ellentét - Folie - Fólie - Foil - Folie - Folio - Folie

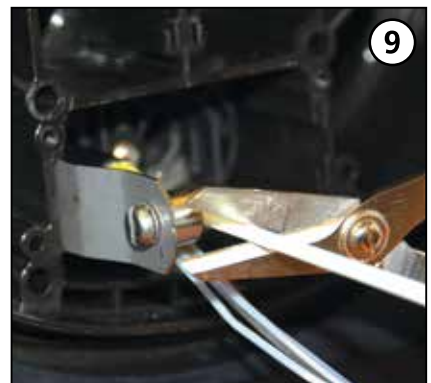
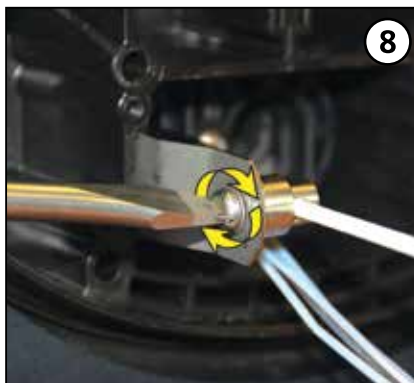
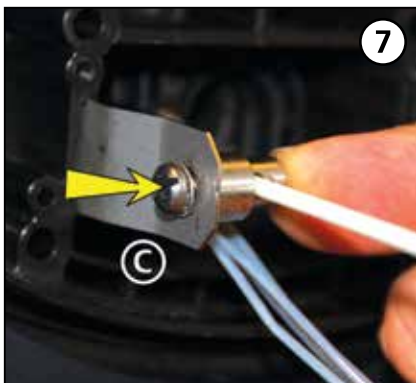
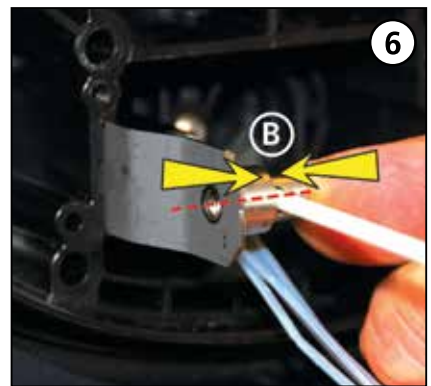
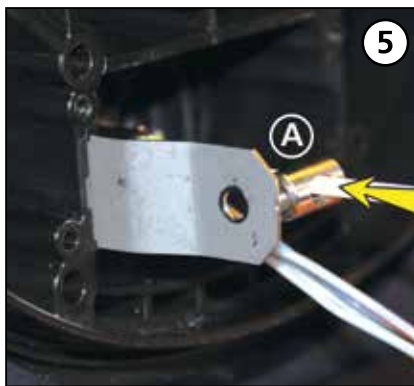
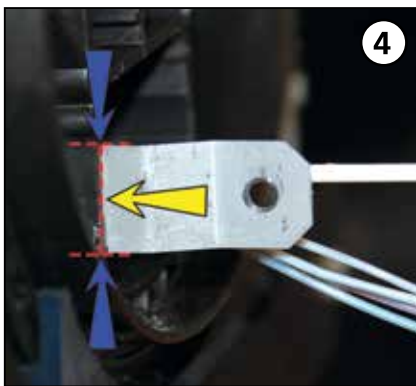
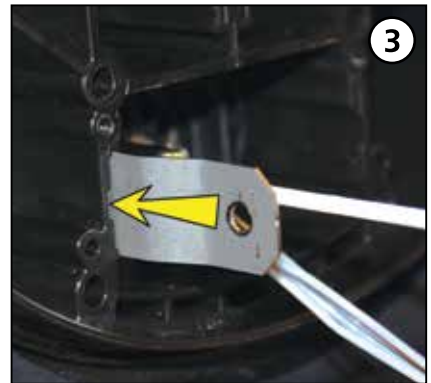
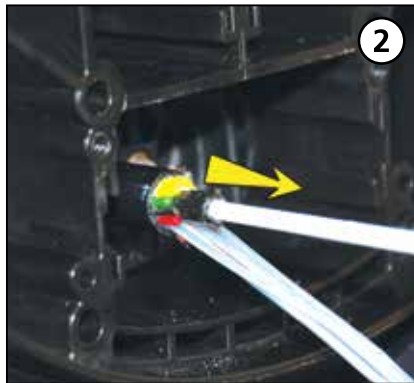
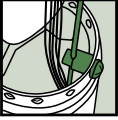

## HellermannTyton

HellermannTyton Data Ltd, Cornwell Business Park, Salthouse Road, Brackmills, Northampton, NN4 7EX, United Kingdom  
Tel: +44 (0) 1604 707420 Fax: +44 (0) 1604 705454 [www.htdata.co.uk](http://www.htdata.co.uk)