



1	Introduction	5
2	Connecting Label Printer to Computer	6
2.1	Print Services Raw-IP and LPR/LPD in MS Windows	7
2.2	Adjusting Windows Printer Setting	7
2.3	Connecting Label Printer via Ethernet Interface	7
2.4	Setting Up a Wi-Fi Connection	8
2.4.1	Connecting Printer to Network	8
2.4.2	Installing a Hotspot	9
2.5	Connecting Label Printer via USB Interface	10
2.6	Connecting Label Printer via RS-232 interface	10
2.7	Setting Up a Bluetooth Connection	10
3	Menu	11
3.1	Structure of the Menu	11
3.2	Navigating in the Menu	12
3.3	Service Key	14
4	Info	15
5	Security	16
6	Configuration	17
6.1	Configuration via Control Panel	17
6.1.1	Printing	17
6.1.2	Labels	18
6.1.3	Ribbon	20
6.1.4	Tearing-off	20
6.1.5	Cutting	21
6.1.6	Peeling-off	21
6.1.7	Labelling	22
6.1.8	Interfaces	23
6.1.9	Errors	26
6.1.10	Region	26
6.1.11	Time	26
6.1.12	Display	27
6.1.13	Interpreter	28
6.1.14	ZPL	28
6.2	Configuration via the Web Interface	29
6.2.1	Status Tab	30
6.2.2	Setup Tab	31
6.2.3	Security Tab	32
6.2.4	Notifications Tab	33
6.2.5	Devices Tab	34
6.2.6	Fonts Tab	34
6.2.7	Help Menu	35
7	Test Functions	36
7.1	Overview	36
7.2	Status Print	36
7.3	Font list	37
7.4	Device List	38
7.5	Test Grid	39
7.6	Wi-Fi Status	40
8	Diagnostic Functions	41
8.1	Printhead	41
8.2	Monitor Mode	42
8.3	Label Profile	43
8.4	Event Log	44
8.5	Record Data Steam	45
8.6	Save Print Image	46
8.7	Save System Log	47

9	Extras	48
9.1	Firmware Update.....	48
9.2	Save Settings	48
9.3	Load Settings	48
9.4	Reset Settings.....	49
9.5	Reset Passwords	49
9.6	Cleaning Interval	49
9.7	Legal Notices	50
10	Help	51
11	Service Menu	52
11.1	Reset Service Counter	52
11.2	Printhead Zero Position X	52
11.3	Printhead Zero Position Y	52
11.4	Printer Model.....	53
11.5	No Branding	53
12	FTP Printer Management	54
12.1	FTP Login.....	54
12.2	FTP Printing	54
12.3	FTP Access to Storage Devices.....	54
12.4	FTP Firmware Update.....	55
13	Storage Devices	56
13.1	Suitable Storage Devices.....	56
13.2	Installation.....	56
13.3	Directory Structure	56
13.4	Writing	57
13.5	Storage Device Functions.....	57
13.5.1	Load Label.....	57
13.5.2	Print File List.....	58
13.5.3	Copy Files.....	58
13.5.4	Format Storage.....	58
13.5.5	Default Storage.....	59
14	Remote Access via VNC	60
15	External Keyboard	61
15.1	Connecting External Keyboard	61
15.2	Keyboard Assignment	61
15.3	Special Key Functions.....	62
16	Index	63

Important information and instructions in this documentation are designated as follows:



Danger!

Draws attention to an exceptionally great, imminent danger to your health or life due to hazardous voltages.



Danger!

Draws attention to a danger with high risk which, if not avoided, may result in death or serious injury.



Warning!

Draws attention to a danger with medium risk which, if not avoided, may result in death or serious injury.



Caution!

Draws attention to a danger with low risk which, if not avoided, may result in minor or moderate injury.



Attention!

Draws attention to potential risks of property damage or loss of quality.



Note!

Advices to make work routine easier or on important steps to be carried out.



Environment!

Gives you tips on protecting the environment.



Handling instruction



Reference to section, position, illustration number or document.



Option (accessories, peripheral equipment, special fittings).

Time

Information in the display.

Choose from the following options for connecting a computer to the label printer:

- Direct connection to the Ethernet interface (6) ▷ "2.3" on page 7.
- Connection via a computer network to the Ethernet interface (6) ▷ "2.3" on page 7.
- Wi-Fi connection via WiFi adapter connected to an USB host interface ▷ "2.4" on page 8.
- Connection to the full-speed USB device interface (5) ▷ "2.5" on page 10.
- Connection to the RS-232 interface ▷ "2.6" on page 10.
- Connection via optional Bluetooth adapter connected to an USB host interface (4/9) ▷ "2.7" on page 10.

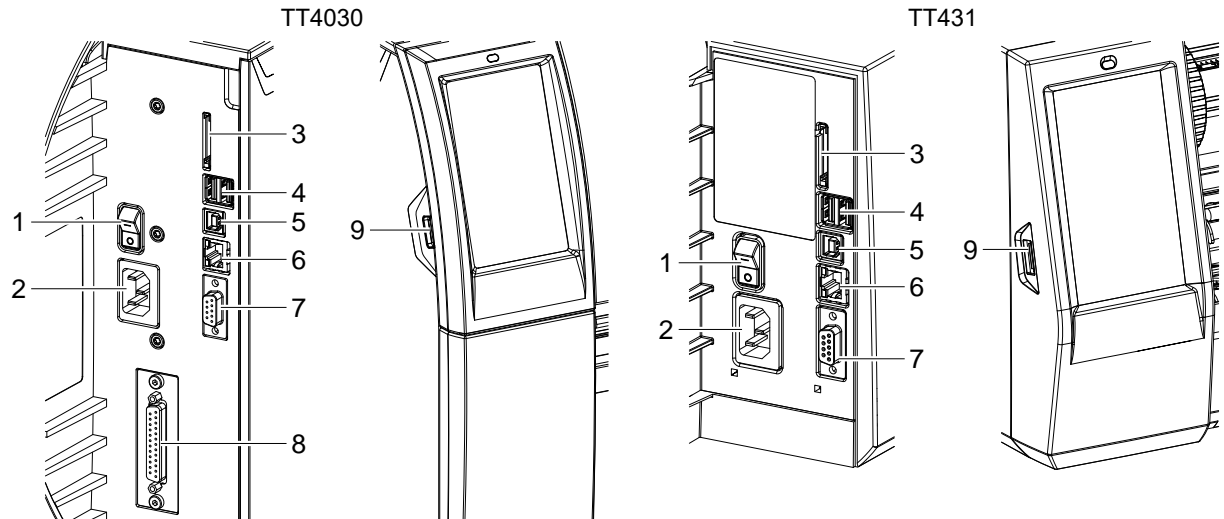

- 1 Power switch
- 2 Power connection jack
- 3 Slot for SD card
- 4 2 USB host ports for keyboard, scanner, USB memory stick, Bluetooth adapter or service key

- 5 USB Hi-speed device port
- 6 Ethernet 10/100 Base-T
- 7 Serial RS-232 port
- 8 I/O interface (Option)
- 9 USB host port for keyboard, scanner, USB memory stick, Bluetooth adapter or service key

Figure 1 Connections

2.1 Print Services Raw-IP and LPR/LPD in MS Windows

- ▶ Install a standard TCP/IP port as additional port for printing.
- ▶ During installation of the new port choose between "Raw" and "LPR"
- ▶ Raw-IP: Enter the same port address in the printer which you have selected during installation.



Notice!

In the delivery status the print services RawIP (Port 9100) and LPD are activated on the printer ▷ page 25.

2.2 Adjusting Windows Printer Setting

When the printer driver valid for your Windows version is installed on your computer, Windows standard applications can be used to edit the label contents and to start the print jobs. To use the Raw-IP or LPR/LPD print services, the Windows printer settings must be adjusted:

1. Open the folder containing the printers via Start > Settings > Printers.
2. Right-click the icon of the label printer.
A pop-up menu appears.
3. Select "Properties" in the pop-up menu.
4. Open the "Details" or "Connections" tab.
This tab contains, among other things, the connections which were also set up when the print services were installed. The names of these connections depend on the installation tool used.
5. Select the Raw-IP or LPR connection.
6. Click **OK**.

2.3 Connecting Label Printer via Ethernet Interface

To connect the label printer to a network jack, a patch cable with an RJ45 plug for 10 Base T or 100 Base T is required.



Attention!

- ▶ **Use a shielded cable to connect the printer to the network.**
- ▶ Connect computer and label printer with a suitable cable.
- ▶ Make the settings for operation of the Ethernet interface ▷ 6.1.8 on page 23.
- ▶ Set up print service if necessary ▷ 2.1 on page 7.
- ▶ Adjust Windows printer setting ▷ 2.2 on page 7.



Attention!

- ▶ **Do not change the settings of the "IP" and "Gateway" on the printer web interface, as otherwise the connection to the printer may be lost.**

2.4 Setting Up a Wi-Fi Connection



2.4.1 Connecting Printer to Network

* Access only with service Wi-Fi stick installed.



Note!

That mode allows to use an existing wireless network for controlling and configuring the printer and for sending print jobs to the printer.

- ▶ Start menu.
- ▶ Select *Setup > Interfaces > Wi-Fi*.
- ▶ Activate *Wi-Fi* ▷ page 23.
- ▶ Select *Operation mode > Connect to network*.
- ▶ Select *Access-Point*.
The search for access-points will be started.
The display shows the available access-points including the hidden access-points.
- ▶ Select an access point and confirm with .
- ▶ For hidden access-points enter the *SSID*.
- ▶ Setup *DHCP* or *IP* and *Mask* and if necessary *Gateway*.
- ▶ If the network is protected a prompt to enter the passkey appears in the printer display. Enter the passkey and select .
- ▶ Set up print service if necessary ▷ 2.1 on page 7.
- ▶ Adjust Windows printer setting ▷ 2.2 on page 7.



Attention!

- ▶ Do not change the settings of the "IP" and "Gateway" on the printer web interface, as otherwise the connection to the printer may be lost.

2.4.2 Installing a Hotspot

- * Access only with service Wi-Fi stick installed.



Note!

In that mode the Wi-Fi stick will be configured as a hotspot. That way a printer-own wireless network will be installed and the printer can be controlled and configured by a mobile device.

- ▶ Start menu.
- ▶ Select *Setup > Interfaces > Wi-Fi*.
- ▶ Activate *Wi-Fi* ▷ page 23.
- ▶ Select *Operation mode > Hotspot*.
The new network gets a SSID generated of the *OEM name* and the last six digits of the MAC address and the password *hotspot!*. Both parameters can be changed if necessary.
- ▶ Select *Hotspot Info*.
The display shows the IP address of the printer, the SSID and the password of the network and a QR code which can be scanned by a mobile device.



Figure 2 Hotspot info

- ▶ Scan the QR code.
The mobile device will be connected with the printer hotspot.
Alternatively the connection can be established using the *Settings* of the mobile device.
Following the network services can be used depending on the settings of both devices.

2.5 Connecting Label Printer via USB Interface

The full-speed USB interface allows the label printer to be operated via a USB interface of a computer running one of the 32bit or 64bit operating systems:

- Windows Vista
- Windows 7
- Windows 8
- Windows 8.1
- Windows 10
- Windows Server 2008
- Windows Server 2008 R2
- Windows Server 2012
- Windows Server 2012 R2.
- Windows Server 2016

A printer driver must be installed if a USB interface will be used for connection. The printer driver for your unit is found on the "Installer DVD" which is included in the scope of delivery or on the internet.

1. Switch label printer off..
2. Connect computer and label printer with an A-B cable.
3. Switch computer on.
4. Place the "Installer DVD" in the DVD drive.
5. Exit all programs currently running.
6. Switch printer on.
The Windows Installation Wizard is started automatically.
7. Follow the on-screen instructions. After successful installation, an icon for the label printer appears in the Windows "Printer" system folder.
8. Click icon in "Printer" system folder and make printer settings if necessary.

2.6 Connecting Label Printer via RS-232 interface

Pin	Designation	Function
1	CD	Carrier Detect
2	TxD	Transmit Data
3	RxD	Receive Data
4	DTR	Data Terminal Ready (not used)
5	GND	Ground
6	DSR	Data Set Ready (not used)
7	RTS	Request to Send
8	CTS	Clear to Send
9	RI	Ring Indication (not used)

Table 1 Pin assignment of the RS-232 interface

- ▶ Connect the 9-pin socket to the matching port of the computer.
For the most computers a 9pin serial SUB-D cable with 1:1 wiring can be used.
- ▶ Install the Windows Printer Driver from the DVD included in the delivery contents of the printer.
- ▶ Configure the interface parameters of the interface matching to the settings of the computer. ▷ page 25.

2.7 Setting Up a Bluetooth Connection

To set up a Bluetooth connection a Bluetooth USB Adapter is required.



Notice!

A Bluetooth software is delivered with the Bluetooth USB Adapter.

1. Connect the Bluetooth USB adapter an to an USB host interface.
2. Switch on the printer.
3. Install the Bluetooth software on the computer.
4. Start the Bluetooth software.
5. Start "Search devices".
The printer will be shown in a list of Bluetooth devices.
6. Optional : For an well-defined connection of the devices select the printer and click "Connect Devices".
Either a passkey will be shown or a window will be opened where a passkey can be set. ▶ Set a passkey if necessary .
The display of the printer shows a prompt to enter the passkey too. ▶ Enter the passkey.
7. Select in the software "Connecting" via "Serial Bluetooth Interface".
The new interface, e.g COM5, will be shown
8. Install the current printer with connection via the new COM interface in the label software or in Windows.

3.1 Structure of the Menu

The menu contains setting options on several levels for configuring the label printer. In addition, the menu features test and diagnostic functions for supporting the configuration or checking the function of the label printer.

1st Selection Level	2nd Selection Level	3rd Selection Level	
 Info			
 Storage			
 Setup	 Printing		
	 Labels		
	 Ribbon		
	 Tearing-off		
	 Cutting		
	 Peeling-off		
	 Labelling		
	 Interfaces	 Ethernet	
		 Wi-Fi	
		 Network services	
		 RS-232	
		 I/O	
	 Errors		
	 Region		
	 Time		
	 Display		
 Interpreter			
 ZPL			
 Test			
 Security			
 Diagnostics			
 Extras			
 Help			
 Service			

Table 2 Structure of the menu

3.2 Navigating in the Menu

The orientation of the display contents is adapted to the orientation of the display in the typical operation position of the printer.



Figure 3 Orientation of the display contents



Note!

At printers with divers possible operation positions the orientation of the display contents can be turned in steps of 90 degree ▷ "6.1.12" on page 27.



Note!

In that manual all following screen shots are shown in the portrait orientation.

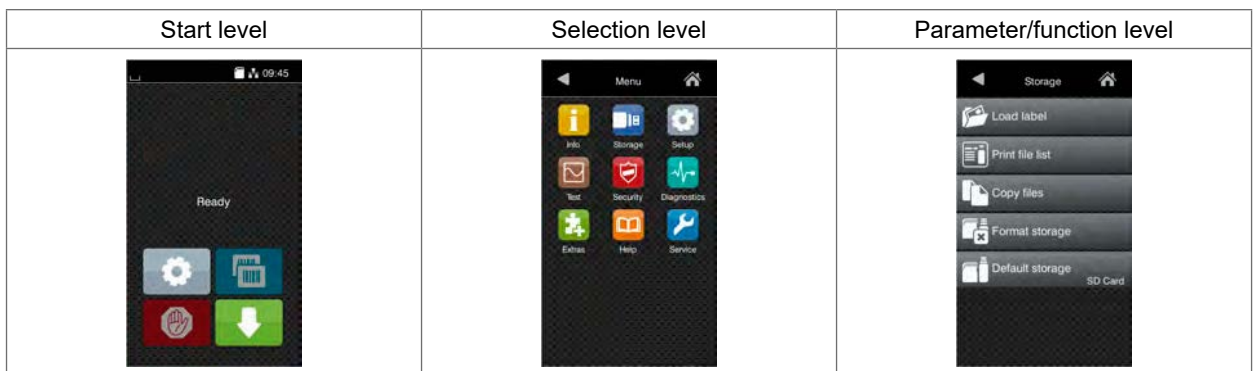





Figure 4 Menu levels

- ▶ To open the menu select  on the start screen.
- ▶ Select a theme in the selection level.
Several themes have substructures again with selection levels.
To return from the current level to the upper one select . To leave the menu select .
- ▶ Continue the selection until the parameter/function level is reached.

- ▶ Start a function. The printer will carry out the function possibly after a preparing dialogue.
 - or -
 - Select a parameter to set. The setup possibilities are depending from the parameter type.

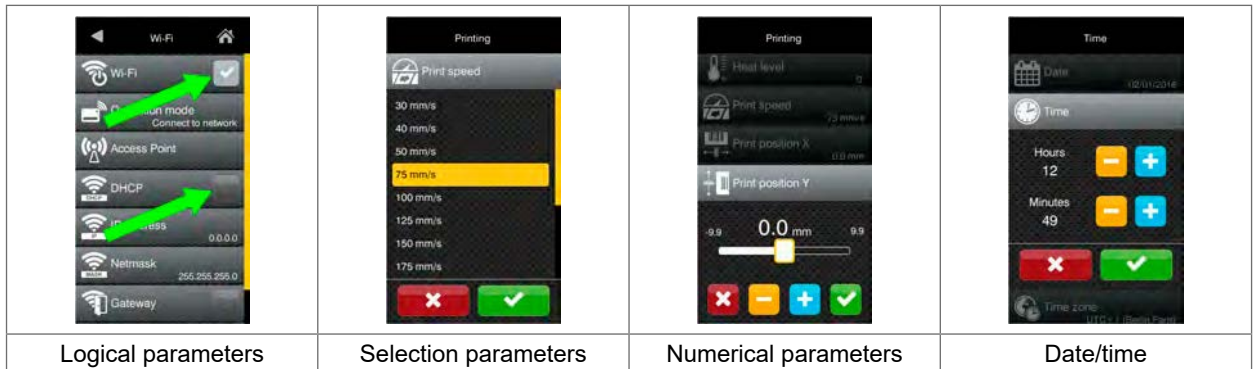

Figure 5 Samples for parameter setting







	<p>Scroll bar for rough value setting</p>
	<p>Decreasing the value step-by-step</p>
	<p>Increasing the value step-by-step</p>
	<p>Return without saving the setting</p>
	<p>Return with saving the setting</p>
	<p>Parameter is disabled, touching enables the parameter</p>
	<p>Parameter is enabled, touching disables the parameter</p>

Figure 6 Buttons for parameter setting

3.3 Service Key

A service key is required for accessing special service functions not accessible to the operator. This key switches the printer to service mode and enables:

- Access to additional configuration parameters
- Resetting of the service counter
- Additional information in the status print and in the device list
- Changing of the device name
- Access to PIN-protected configuration parameters and functions without entering the PIN
- Access to configuration parameters for optional assemblies, even if they are not currently installed

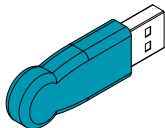

Figure 7 Service key



Attention!

Incorrect settings and data loss via unauthorized access.

Access protection is deactivated when the service key is inserted. Operation of the printer by unauthorized persons can lead to incorrect settings and data loss in this case.

- ▶ **Provide the service key to authorized persons only.**
- ▶ **Remove service key after service work and store it in a secure location.**

- ▶ Insert service key into a USB host interface of the printer.

The service key also can be inserted while the device is switched on.



Notice!

In this document, parameters and functions which are only accessible when the service key is inserted are indicated using the following note:

 **Access only with service key inserted!**

The  *Info* function provides an overview of important status information on the display of the printer.

- ▶ Start menu.
- ▶ Select *Info*.
- ▶ Return with *Close*.

The following parameters are displayed:

Line	Meaning	Example
1	Printer type Version number and creation date of the firmware	TT4030 <i>Firmware V5.13</i> <i>Dec 18, 2017</i>
2	IPv4 address of the printer when connected to a network via Ethernet MAC address of the network adapter on the PCB CPU	Ethernet <i>IPv4 10.20.2.42</i> <i>MAC 00:02:e7:05:cb:bf</i>
3	IPv4 address of the printer when connected to a network via Wi-Fi MAC address of the Wi-Fi adapter	Wi-Fi <i>IPv4 192.168.10.1</i> <i>MAC e8:4e:06:3e:72:26</i>
4	Zeroconf host name	mDNS <i>hellermann-05cbbf.local</i>
5	Operative time and number of printed labels	Hours/no. of labels <i>150h/1208</i>
6	Previously printed paper lengths with thermal direct printing / thermal transfer printing	Thermal/Transfer <i>29.04m/32.52m</i>
7	Resolution, number of dots and revision of the printhead	Printhead <i>300dpi, 1248dots</i> <i>Rev. 2.1.0</i>
8	Results of the label sensor calibration	Label sensor <i>Brightness 13-38</i>
9	Serial number of the PCB CPU, Revision of PCB CPU and the FPGA	PCB <i>S/N 164162036456</i> <i>PCB Rev. 0</i> <i>FPGA Rev. 13</i>

Table 3 *Info* display

6.1  Configuration via Control Panel

A host of parameters for configuring the printer are found in the *Setup* menu.

- ▶ Configure the printer via the control panel during initial commissioning and when making major changes to the operational conditions.
- ▶ For changes required for processing different print jobs use software settings.









Notice!

The *Setup* menu can be protected from unauthorized access via a code number (PIN).

6.1.1  Printing

- ▶ Start menu.
- ▶ Select *Setup > Printing*.

Parameter	Meaning	Default
 <i>Heat level</i>	<p>Heating value for compensating for the differing thermal behavior of printheads. Changing this value is then especially necessary if the printing intensity has changed after replacing the printhead.</p> <ul style="list-style-type: none"> ▶ To adapt the printing intensity when using different media, print speeds or printing contents, you should change the heat level in the software. <p>The settings of configuration and software are added together. The <i>Heat level</i> setting also affects the test printouts.</p>	0
 <i>Print speed</i>	<p>Basic print speed setting.</p> <p>The print speed can be re-specified for each print job via software. The basic setting is not changed by this.</p> <p>The print speed setting also affects the test printouts.</p>	50 mm/s
 <i>Print position X</i>	<p>Shifting of the entire print image perpendicular to the direction of paper flow.</p> <p>The absolute shifting is limited by the margins of the print zone. Those are determined by the width of the printing line on the printhead.</p> <p>The setting can also be adjusted by the software.</p> <p>The settings of configuration and software are added together.</p>	0.0 mm
 <i>Print position Y</i>	<p>Shifting of the entire print image in the direction of paper flow. With positive values, printing begins later in the direction of paper flow.</p> <p>Shifting of the print image in the direction of paper flow also influences the peel and cut positions.</p> <ul style="list-style-type: none"> ▶ Correct the <i>Peel position</i> and <i>Cut position</i> parameters by the same value in the opposite direction. <p>The setting can also be adjusted by the software.</p> <p>The settings of configuration and software are added together.</p>	0.0 mm
 <i>Backfeed</i>	<p>Method for backfeeding the label medium.</p> <p>Backfeeding is necessary in the cutting and peel-off modes since a label is pushed out passed the front edge of the next label above the print line when peeling off/cutting.</p> <p><i>always</i>: Backfeeding occurs independently of label contents.</p> <p><i>smart</i>: Backfeeding only occurs when the next label is not yet completely prepared when peeling off/cutting the current label. Otherwise, the second label is pushed on and completed after removal of the first label without backfeeding.</p>	TT4030, TT431 <i>smart</i> HERMES Q PX Q <i>always</i>
 <i>Backfeed position</i>	Offset of the backfeed movement	1.0 mm















Parameter	Meaning	Default
 <i>Print on demand</i>	<p>Peel-off mode : Behavior after removing a label from the peel position <i>On:</i> The next label will be printed and peeled-off after touching  <i>Off:</i> The next label will be printed and peeled-off immediately</p> <p>Cut mode : Behavior between the cuts <i>On:</i> After cutting the next label will be printed and cut after touching  <i>Off:</i> All labels will be printed and cut nonstop</p>	<i>Off</i>
 <i>Reprint</i>	<p>Printing of another label with the information of the previous print job by touching .</p> <p>This function can be executed until the print buffer is cleared with .</p> <p><i>Re-render:</i> Adaption of counter values, variable data can be newly put in. <i>Duplicate:</i> New label is identical with the last label of the print job. <i>Off:</i> No reprint</p>	<i>Re-render</i>
 <i>Single label buffer</i>	The next label will be processed only when the current one has finished printing.	<i>Off</i>
 <i>Length scale</i>	Eliminate deviations of the print length from the length set in the programming	<i>0,0%</i>
 <i>Slippage correction</i>	To correct the slippage of the media transport the positioning of the print image will be re-adjusted to the position of the last detected label front edge considering the programmed label distance.	<i>Off</i>

Table 5 Parameters of the *Setup > Printing* menu

6.1.2 Labels

- ▶ Start menu.
- ▶ Select *Setup > Labels*.

Parameter	Meaning	Default
 <i>Label sensor</i>	<p>Method for detecting the starting end of the label.</p> <p><i>Gap Sensor:</i> Detection using changes in the transparency between the label and label gap.</p> <p><i>Bottom-Reflect:</i> Detection using reflex marks on the bottom of the medium.</p> <p><i>Continuous media:</i> Checking the existence of media only.</p>	<i>Gap sensor</i>
 <i>Calibrate label sensor</i>	To adapt the printer electronics to the label sensor and * TT4030 / TT431 / Hermes Q: the used liner material.	
 <i>Extrapolate labels</i>	The positions of the labels which are between the label sensor and the printhead are calculated from the first label recognized by the sensor and the programmed label distance. That way those labels can be printed although the printhead previously was open.	<i>Off</i>
 <i>Ignore paper end</i>	Suppression of wrong <i>Out of paper</i> error messages when using labels with transparent liner.	<i>Off</i>
 <i>Sensor unwinder</i>	<p>* Only at HERMES Q!</p> <p><i>On:</i> Sensor for monitoring the label supply roll is activated. <i>Off:</i> Sensor for monitoring the label supply roll is not activated.</p>	<i>On</i>



Parameter	Meaning	Default
 Warn level labels	* Only at HERMES Q! Threshold diameter (80–240 mm) of the label supply roll, if the value is undershot the "labels low" message will be activated.	Off
 Pause on warning	The print job will be interrupted when the "labels low" message appears	Off

Table 6 Parameters of the *Setup > Labels* menu*Calibrate label sensor***TT4030, TT431 / Hermes Q**

- ▶ Start menu.
- ▶ Select *Extras > Calibrate label sensor*.
The display shows *Step 1/2 Remove labels*.
- ▶ Remove labels and select *Continue*.
After a few seconds the display shows *Step 2/2 Insert liner*.
- ▶ Insert the liner without labels and select *Continue*.
After a few seconds the message *Sensor successfully calibrated* appears.
The display shows the characteristic values of the sensors e.g. *Brightness 12-28*.
- ▶ Select *Continue* to quit the function.

6.1.3 Ribbon

- ▶ Start menu.
- ▶ Select *Setup > Ribbon*.





Parameter	Meaning	Default
 <i>Transfer print</i>	<i>On</i> : Sensor for monitoring the transfer ribbon is activated. <i>Off</i> : Sensor for monitoring the transfer ribbon is not activated. The setting can be overwritten for each print job via software. The basic setting is not changed by this.	<i>On</i>
 <i>Warn level ribbon</i>	Threshold diameter (32–74 mm) of the ribbon supply roll, if the value is undershot the "ribbon low" message will be activated	<i>Off</i>
 <i>Pause on warning</i>	The print job will be interrupted when the "ribbon low" message appears	<i>Off</i>
 <i>Monitor ink side</i>	Setting of the ribbon unwinding direction The print job will be interrupted when the wrong ribbon winding direction has been detected. The error message "Ribbon ink side" appears.	<i>Off</i>
 <i>Ribbon tension</i>	* Only at TT431 Adaptation of the winding torque at the ribbon rewinder to different ribbons.	0

Table 7 Parameters of the *Setup > Ribbon* menu

6.1.4 Tearing-off

- ▶ Start menu.
- ▶ Select *Setup > Tearing-off*.



Parameter	Meaning	Default
 <i>Tear-off mode</i>	Positioning the label medium for tearing off at the tear-off plate. <i>On</i> : Additional advancement of the label medium which positions the label gap after the last printed label at the dispense plate. <i>Off</i> : Label advance stops once the last label has fully passed the print line.	<i>On</i>
 <i>Tear-off position</i>	Shifting of the tear-off position in the direction of paper flow. With positive values, the label strip is transported farther out of the printer.	0.0 mm

Table 8 Parameters of the *Setup > Tearing-off* menu

6.1.5 Cutting

- * **Only with cutter installed!**
- * **Not at HERMES Q and PX Q!**
 - ▶ Start menu.
 - ▶ Select *Setup > Cutting*.



Note!

The content of the menu is depending on the cutter type and described in the manual of the cutter.

6.1.6 Peeling-off

- * **Not at EOS!**
- *  **If peel-off module or I/O interface are not installed, access only with service key inserted.**
 - ▶ Start menu.
 - ▶ Select *Setup > Peeling-off*.



Parameter	Meaning	Default
 <i>Peel-off position</i>	Shift the position of the dispensed label relative to the dispensing edge. The setting can also be adjusted by the software. The settings of configuration and software are added together.	0.0 mm
 <i>Backfeed delay</i>	Delay time between removing the label from the peel position and the backfeed of the label.	250 ms

Table 9 Parameters of the *Setup > Peeling-off* menu

6.1.7 Labelling

* Not at TT431

*  If applicator is not installed, access only with service key inserted.

- ▶ Start menu.
- ▶ Select *Setup > Labelling*.















Parameter	Meaning	Default
 <i>Transfer mode</i>	Setting the operation mode <i>Stamp on, Roll on, Blow on</i>	<i>Stamp on</i>
 <i>Cycle sequence</i>	Setting the application mode <i>Print-Apply / Apply-Print</i> <i>Print-Apply:</i> An external start signal releases the print of a label and following the application of the label. After a cycle is complete, the pad without label waits in the start position. <i>Apply-Print:</i> An extra signal starts the print of the first label and the transfer of the label to the pad. The external start signal releases the application of the label and following the print and transfer of the next label. After a cycle is complete, the pad with a label is in the waiting position.	<i>Print-Apply</i>
 <i>Waiting position</i>	* Only at <i>Transfer mode = Blow on</i> and <i>Cycle sequence = Apply-Print</i> <i>up:</i> Pad waits in the start position for the start signal <i>down:</i> Pad waits in the labelling position for the start signal	<i>up</i>
 <i>Blow time</i>	* Only at <i>Transfer mode = Roll on</i> Switch-on time (max. 2,5 s) of the blowing air for the label transfer	<i>1000 ms</i>
 <i>Roll-on time</i>	* Only at <i>Transfer mode = Roll on</i> Dwell time (max. 5 s) of the pad in the labelling position	<i>1000 ms</i>
 <i>Support delay on</i>	Setting the switch-on delay (max. 2,5 s) for the supporting air between print start and switching on the supporting air. The delay prevents swirling at the front of the label and, consequently, avoids faults when the label is being picked up from the printer.	<i>0 ms</i>
 <i>Support delay off</i>	Setting the switch-off delay (max. 2,5 s) for the supporting air between the end of label forwarding and switching on the supporting air. The delay can be useful to separate the rear edge of the label from the carrier to avoid errors and to improve the accuracy of label positioning	<i>0 ms</i>
 <i>Start delay</i>	Delay (max. 2,5 s) between start signal and the start of an labelling cycle. Allows e.g. the use of product sensors at conveyors.	<i>0 ms</i>
 <i>Lock time</i>	All start signals coming in following the first start signal are ignored when they arrive within the lock time (max. 2,5 s).	<i>0 ms</i>
 <i>Vacuum delay</i>	<i>On</i> - The vacuum will be switched on after the label feed is completed. <i>Off</i> - The vacuum will be switched on when the label feed starts.	<i>Off</i>
 <i>Vacuum control</i>	Setting the label transfer check from printer to pad and from pad to product by the vacuum sensor	<i>On</i>
 <i>Label hand-over</i>	<i>Passive</i> - The pad waits in front of the dispense edge for the label. <i>Active</i> - The pad moves to the dispense edge and takes the label.	<i>Passive</i>
 <i>Cleaning blow</i>	Activation of a short blow impulse after the application of the label to clean the suction channels.	<i>Off</i>
 <i>Peel-off position</i>	Shift the position of the dispensed label relative to the dispensing edge. The setting can also be adjusted by the software. The settings of configuration and software are added together.	<i>0.0 mm</i>

Table 10 Parameters of the *Setup > Labelling* menu

6.1.8  Interfaces

- ▶ Start menu.
- ▶ Select *Setup > Interfaces*.

 Ethernet







Parameter	Meaning	Default
 <i>Hostname</i>	Unique identification of the printer in a network in a human readable format	<i>generated of OEM name and the last six digits of the MAC address</i>
 <i>DHCP</i>	Method of issuing IP address <i>On</i> : Dynamic issuing of IP address by the DHCP server <i>Off</i> : Direct issuing of the IP address by the operator	<i>On</i>
 > <i>IP address</i>	IP address of the label printer. Only valid with <i>DHCP = Off</i> .	-
 > <i>Netmask</i>	Subnet mask (classification and address range) of the local network. Only valid with <i>DHCP = Off</i> .	-
 > <i>Gateway</i>	Connection address between the local network and other networks.	<i>Off</i>
 >> <i>Gateway address</i>	The IP address of the computer (router) on the network through which the connection can be established is used for this. The address of the router can also be issued via DHCP.	-
 > <i>DNS-Server</i>	Setting the IP address of a DNS server manually The DNS server resolves the internet addresses to IP addresses e.g. to select network services such as NTP per domain name.	-

Table 11 Parameters of the *Setup > Interfaces > Ethernet* menu



Wi-Fi

* Access only with Wi-Fi stick installed.

Parameter	Meaning	Default
<i>Wi-Fi</i>	Activation of the Wi-Fi interface	<i>Off</i>
> <i>Operation mode</i>	Selection of the operation mode <i>Connect to network:</i> Connection of the printing to an existing wireless network <i>Hotspot:</i> Installation of a printer-own wireless network to connect mobile devices to the printer	<i>Connect to network</i>
Operation mode <i>Connect to network</i>		
>> <i>Access-Point</i>	Selection of the Access Point to setting up the Wi-Fi connection.	-
>> <i>DHCP</i>	▷ <i>Ethernet > DHCP</i>	<i>On</i>
>>> <i>IP adress</i>	▷ <i>Ethernet > IP adress</i>	-
>>> <i>Netmask</i>	▷ <i>Ethernet > Netmask</i>	-
>>> <i>Gateway</i>	▷ <i>Ethernet > Gateway</i>	<i>Off</i>
>>>> <i>Gateway address</i>	▷ <i>Ethernet > Gateway address</i>	-
>>> <i>DNS-Server</i>	▷ <i>Ethernet > DNS-Server</i>	-
Operation mode <i>Hotspot</i>		
>> <i>Hotspot SSID</i>	Name of the printer-own wireless network	generated of the <i>OEM name</i> and the last six digits of the <i>MAC address</i>
>> <i>Hotspot password</i>	Password of the printer-own wireless network	<i>hotspot!</i>
>> <i>Hotspot info</i>	Display of the IP adress of the hotspot, the SSID and the password Display of a QR code, which can be scanned with a mobile device to connect the device to the printer-own wireless network	-

Table 12 Parameters of the *Setup > Interfaces > Wi-Fi* menu

 **Network Services**













Parameter	Meaning	Default
 <i>FTP</i>	Activation of the File Transfer Protocol	<i>On</i>
 <i>LPD</i>	Activation of the network printing service LPD	<i>On</i>
 <i>RawIP</i>	Activation of the network printing service RawIP and selection of the port address	<i>On</i>
 <i>> RawIP Port</i>	Selection of the port address for RawIP	<i>9100</i>
 <i>> RawIP Timeout</i>	Setting the timeout for the interruption of unused connections	<i>Default</i>
 <i>Website</i>	Activation of the Hypertext Transfer Protocol for the access to the internal printer website	<i>On</i>
 <i>Web service</i>	Activation of the Simple Object Access Protocol	<i>Off</i>
 <i>SNMP</i>	Data exchange between printer and management station via Simple Network Management Protocol	<i>Off</i>
 <i>> SNMP community</i>	Keyword to assign the SNMP rights	<i>public</i>
 <i>VNC server</i>	Activation of the VNC server for remote access to the control panel	<i>Off</i>
 <i>Zeroconf</i>	Activation of the auto-configuring Zeroconf method for adhoc networks	<i>On</i>
 <i>OPC UA</i>	Activation of the protocol OPC UA for multi-vendor machine to machine communication	<i>Off</i>

Table 13 Parameters of the *Setup > Interfaces > Network services* menu

 **RS-232**



Parameter	Meaning	Default
 <i>Baud rate</i>	Speed (in Baud) of data transfer	<i>115.200</i>
 <i>Handshake</i>	Data transfer protocol	<i>RTS/CTS</i>

Table 14 Parameters of the *Setup > Interfaces > RS-232* menu



Note!

The following parameters cannot be changed: **Data bits: 8, Stop bits: 1, Parity: None**

 **I/O**

*

**Access only with I/O interface installed!
Not at TT431**



Note!

The content of the menu is depending on the installed interface and described in the documentation of the interface.

6.1.9 Errors

- ▶ Start menu.
- ▶ Select *Setup > Errors*.





Parameter	Meaning	Default
 <i>Error-Reprint</i>	<i>On</i> : With a correctable error and corresponding troubleshooting, the label being printed when the error occurs is repeated. If an error occurs in the mode <i>Backfeed=smart</i> after the first label part has been printed, the label cannot be repeated. <i>Off</i> : Print job is continued with the next label.	<i>On</i>
 <i>Syntax error</i>	Printer switches to error mode after receipt of an incorrect command.	<i>On</i>
 <i>Barcode error</i>	<i>On</i> : With faulty barcode contents or size specifications, printing is interrupted. <i>Off</i> : Printing is not interrupted if an error occurs. If barcode contents are faulty, the printer attempts to replace the incorrect data with valid characters (e.g. zeros). If barcode size specifications are faulty, a gray area is printed instead of the barcode.	<i>On</i>
 <i>Network error</i>	Printer switches to error mode when problems with the network connection occur.	<i>Off</i>

Table 15 Parameters of the *Setup > Errors* menu

6.1.10 Region

- ▶ Start menu.
- ▶ Select *Setup > Region*.





Parameter	Meaning	Default
 <i>Language</i>	Setting the display language	<i>English</i>
 <i>Country</i>	Setting the country-specific date and time formats. The time formats can also be overwritten via software. The changes are not saved permanently, however.	<i>Germany</i>
 <i>Keyboard</i>	Setting of the keyboard layout when using an external keyboard or the soft keyboard on the printer display.	<i>Automatic (=Country)</i>

Table 16 Parameters of the *Setup > Region* menu

6.1.11 Time

- ▶ Start menu.
- ▶ Select *Setup > Time*.

Parameter	Meaning	Default
 <i>Date</i>	Setting of the system date in the format DD.MM.YYYY. The print output of the date occurs in the format set via the <i>Country</i> parameter. The date can also be changed via software. The change is not saved permanently, however.	-





Parameter	Meaning	Default
 <i>Time</i>	Setting the system time in the HH:MM:SS format. When changing the time, ensure that the <i>Timezone</i> , <i>Daylight saving</i> and <i>Date</i> parameters are set correctly. The time can also be synchronized automatically via the internet using the Ethernet interface. The print output of the time occurs in the format set via the <i>Country</i> parameter. The time can also be changed via software. The change is not saved permanently, however.	-
 <i>Time zone</i>	Adaptation of the time display of the printer to the time zone in relation to UTC (Universal Time Coordinated).	UTC+1
 <i>Daylight saving</i>	Selection of the daylight saving regulation applicable for the region. The time is then changed automatically.	EU
 <i>Time synchronisation</i>	Activation of a service to synchronize date and time of the printer.	NTP
 <i>> Time server</i>	* for <i>Time synchronisation</i> ≠ Off Address of the time server	

Table 17 Parameters of the *Setup > Time* menu

6.1.12  Display

- ▶ Start menu.
- ▶ Select *Setup > Display*.









Parameter	Meaning	Default
 <i>Orientation</i>	Adaptation of the display contents to the display orientation.	0°
 <i>Brightness</i>	Brightness of the LCD display.	8
 <i>Time powersave</i>	Time between the last operation and activation of energy-saving mode.	5 min
 <i>Peripheral button</i>	Activation/Deactivation of the start button	On
 <i>Reprint button</i>	Activation/Deactivation of the reprint button	On
 <i>Pause button</i>	Activation/Deactivation of the pause button	On
 <i>Cancel button</i>	Activation/Deactivation of the cancel button	On
 <i>Feed button</i>	Activation/Deactivation of the feed button	On

Table 18 Parameters of the *Setup > Display* menu

6.1.13  Interpreter

- ▶ Start menu.
- ▶ Select *Setup > Interpreter*.







Parameter	Meaning	Default
 <i>Character set</i>	Selection of the character set table for adaptation to the computer system used. Switching the character set via software is not possible. Characters not available in the selected character set can be accessed using the Unicode table.	<i>UTF-8</i>
 <i>USB</i>	Choosing between the programming languages JScript and ZPL for data transfer via USB interface	<i>JScript</i>
 <i>RS-232</i>	Choosing between the programming languages JScript and ZPL for data transfer via RS-232 interface	<i>JScript</i>
 <i>FTP</i>	Choosing between the programming languages JScript and ZPL for data transfer via FTP	<i>JScript</i>
 <i>LPD</i>	Choosing between the programming languages JScript and ZPL for printing with LPD	<i>JScript</i>
 <i>RawIP</i>	Choosing between the programming languages JScript and ZPL for printing with RawIP	<i>JScript</i>
 <i>Bluetooth</i>	Choosing between the programming languages JScript and ZPL for data transfer via Bluetooth * only with Bluetooth adapter installed	<i>JScript</i>

Table 19 Parameters of the *Setup > Interpreter* menu6.1.14  ZPL

- ▶ Start menu.
- ▶ Select *Setup > ZPL*.



Parameter	Meaning	Default
 <i>> Printing width</i>	Setting the print width for ZPL programming	<i>maximum print width</i>
 <i>> Label length</i>	Setting the label length for ZPL programming	<i>150.0 mm</i>

Table 20 Parameters of the *Setup > ZPL* menu

6.2 Configuration via the Web Interface

The parameters accessible via the control panel can also be set via the web interface contained in the firmware of the printer.

The printer web interface can be accessed with a browser (e.g. Microsoft Internet Explorer, Mozilla Firefox) with JavaScript activated via the Ethernet interface or the optional Wi-Fi interface.

Calling Up the Web Interface



Attention!

Whenever settings are changed via the web interface you are requested to enter the user name "admin" and a password. The default value of the password is also "admin". The password can be changed via the web interface (▷ "Setup Tab" page 32).

- ▶ Start the browser.
- ▶ Call the web interface by entering the IP address via HTTP (e.g. `http://192.168.100.208`).
The "Status" tab is open on the home screen.

The web interface contains the following tabs:

- Status: general status description ▷ page 30.
- Setup: configuration parameter settings ▷ page 31.
- Security: password settings ▷ page 32.
- Notifications: settings for sending messages via SNMP or Email ▷ page 33.
- Devices: list of the hardware and optional components ▷ page 34.
- Fonts: overview of the available fonts ▷ page 34.

6.2.1 Status Tab

Printer Administration

Status Setup Security Notifications Devices Fonts Help

TT4030
 Firmware: 5.32 (Mar 05, 2020)
 S/N: 164162036456

Operative time		Number of labels	
Total	581h 33min	Total	2835
Service	-	Service	-

Thermal transfer		Thermal direct	
Total	105.299 m	Total	32.844 m
Service	-	Service	-

Date - Time	Message
2020-04-02 08:15:14	Startup

Update Interval [s]: Min: 1 1 Max: 10

Printer Display

Ready

Settings Printer Hand Download

Figure 8 "Status" tab on the printer web interface

The following information is contained in the left top section of the "Status" tab:

- Printer type
- Firmware version
- Serial number of the PCB CPU
- Operative time of the printer
- Number of labels printed since commissioning
- Previously printed paper length with thermal transfer printing
- Previously printed paper length with thermal direct printing

A list of the events which have occurred since the printer was switched on is to be found in the left bottom section of the tab.

The right section of the tab shows the current printer display information.

**Notice!**

By clicking the buttons the printer can be operated in the same manner as by using the touchscreen on the device.

When the printer display is selected by mouse click, it is possible to use the computer keyboard in the same manner like an External Keyboard (> "15.3" on page 62) e.g. for entering variable input data.

6.2.2 Setup Tab

On the "Setup" tab all the configuration parameters can be set which are also accessible via the control panel in the Setup menu.

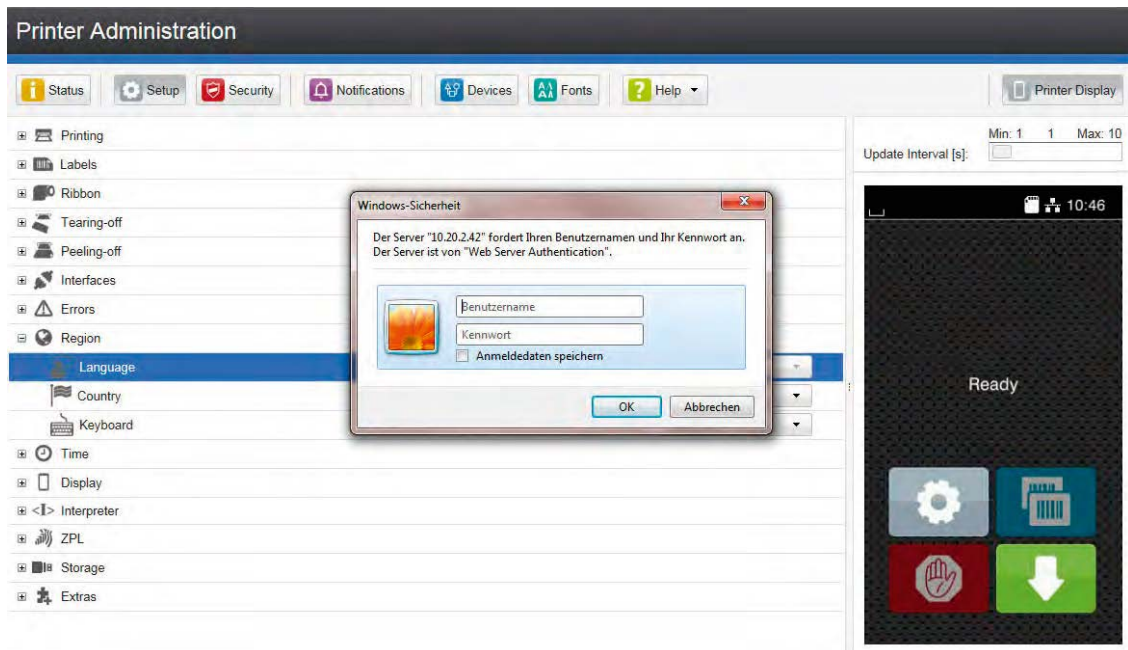

Figure 9 "Setup" tab on the printer web interface

To change a parameter:

1. Locate parameter in the tree structure.
2. Set the value of the parameter at the right end of the concerning line.
A prompt to enter user name and password appears ▷ page 16.
3. Enter user name and password and click **OK**.

6.2.3 Security Tab

On the "Security" tab the access rights for several printer function can be set.

The tab contains the same parameters as the *Security* menu of the Setup ▸ page 16.

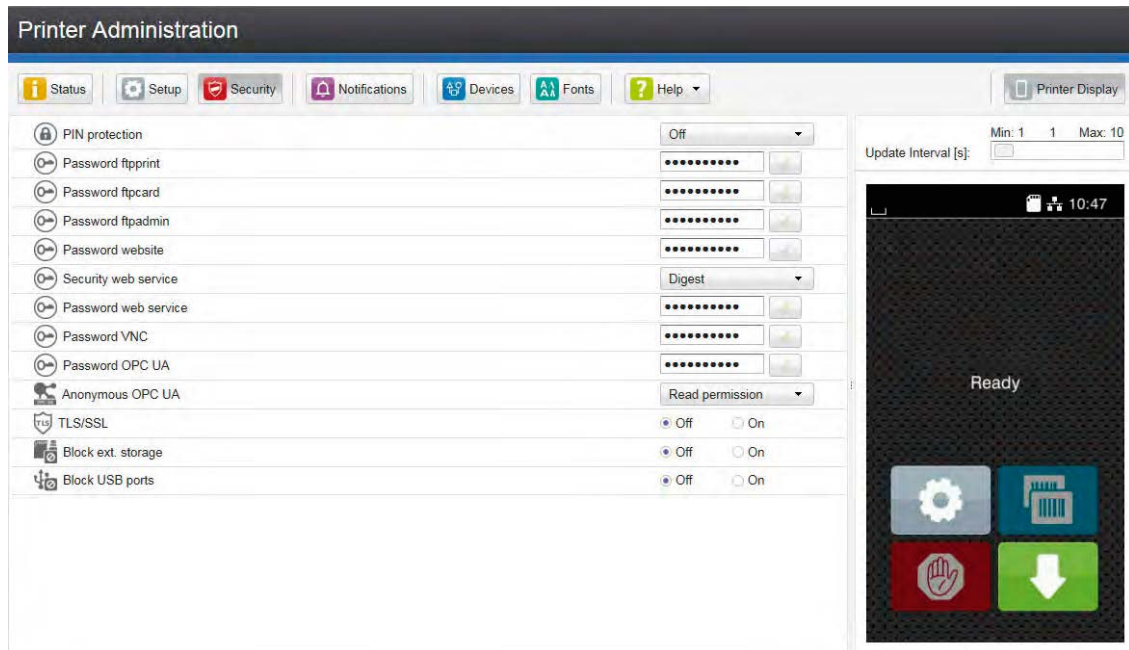

Figure 10 "Security" tab on the printer web interface

To change a parameter:

1. Locate parameter in the tree structure.
2. Set the value of the parameter at the right end of the concerning line.
A prompt to enter user name and password appears ▸ page 16.
3. Enter user name and password and click **OK**.

6.2.4 Notifications Tab

The "Notifications" tab allows to send status and error messages automatically to a SNMP manager or via e-mail to selected addresses via the Ethernet interface or WiFi.

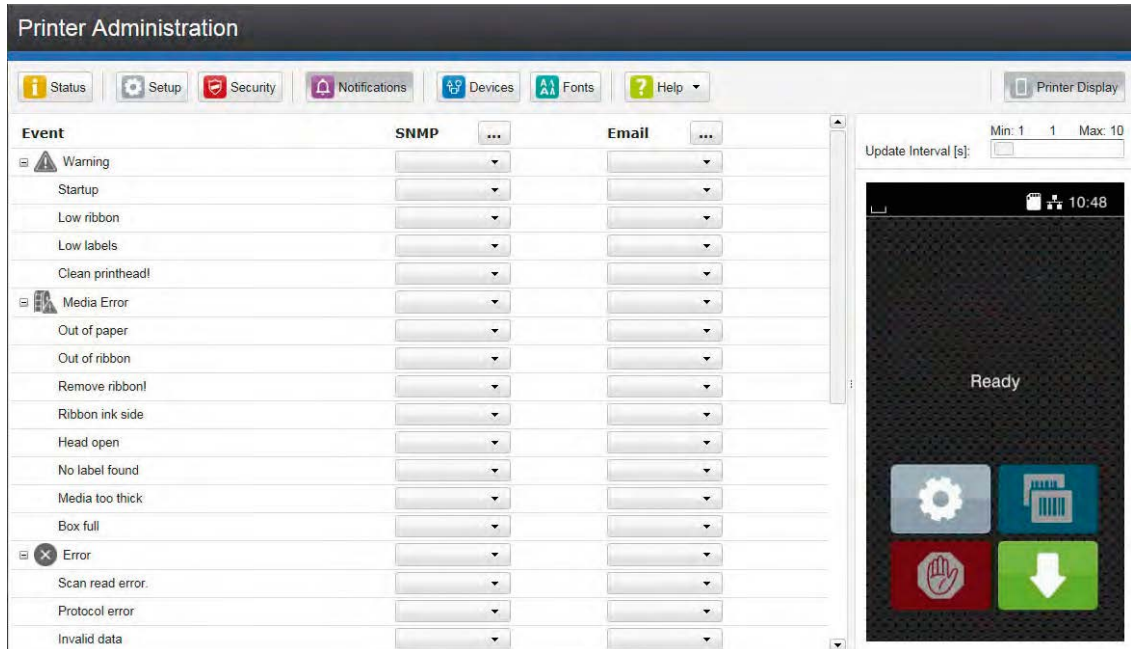

Figure 11 "Notifications" tab on the printer web interface

To change settings:

1. If necessary expand the tree structure.
2. Locate and click the message in the tree structure.
3. Select management station or e-mail address.
4. If the selection at SNMP or e-mail is empty, click the **...** button next to the concerning title and define the SNMP sinks or e-mail addresses.

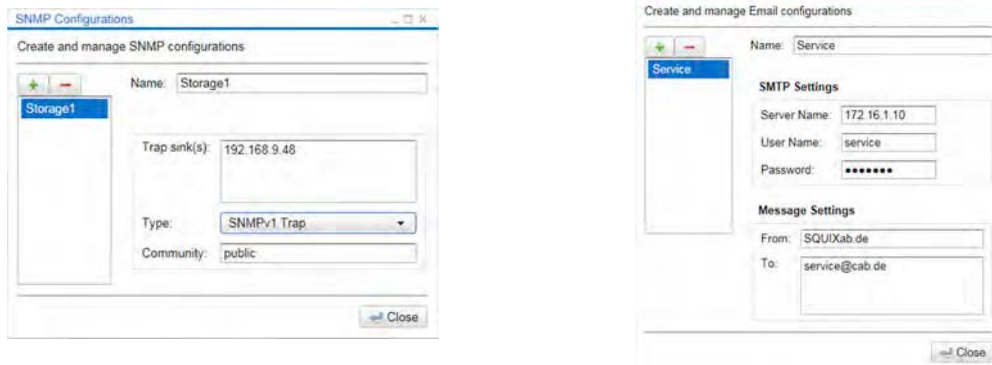

Figure 12 Dialog boxes for SNMP and e-mail configuration

6.2.5 Devices Tab

The "Devices" tab provides an overview of the most important hardware components installed in the printer and the optional devices connected.

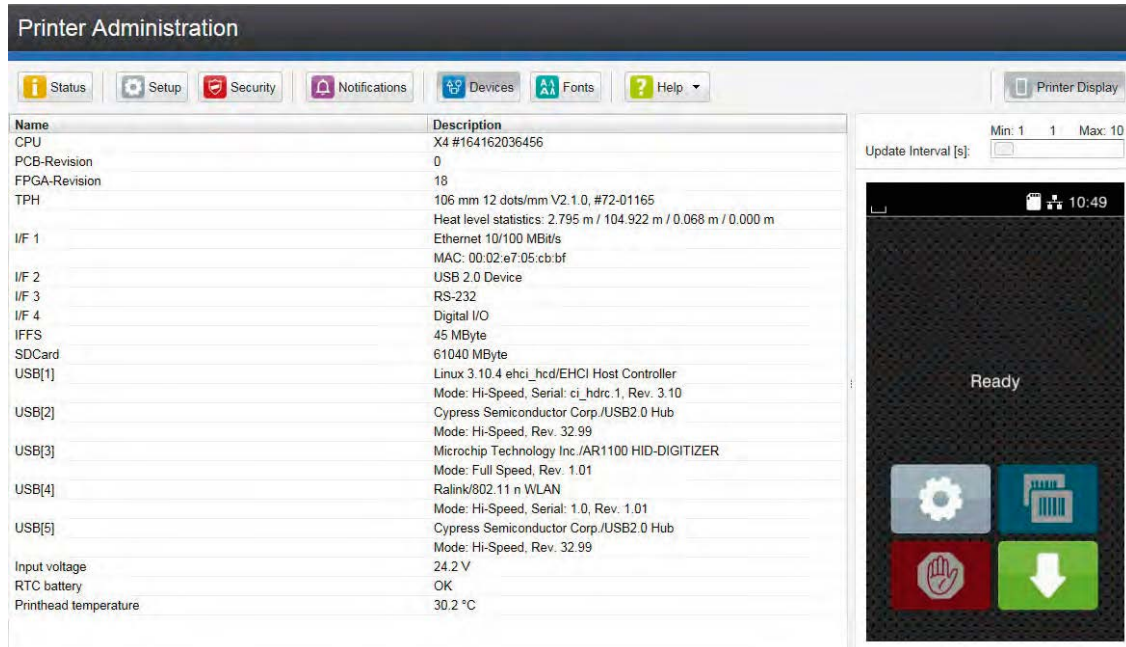

Figure 13 "Devices" tab on the printer web interface

The contents of the display correspond with those of the *Device list* ▷ "Table 22" on page 38.

6.2.6 Fonts Tab

The most important parameters of the fonts available in the printer are listed on the "Fonts" tab. The table contains both the original fonts in the printer and other fonts loaded into the printer.

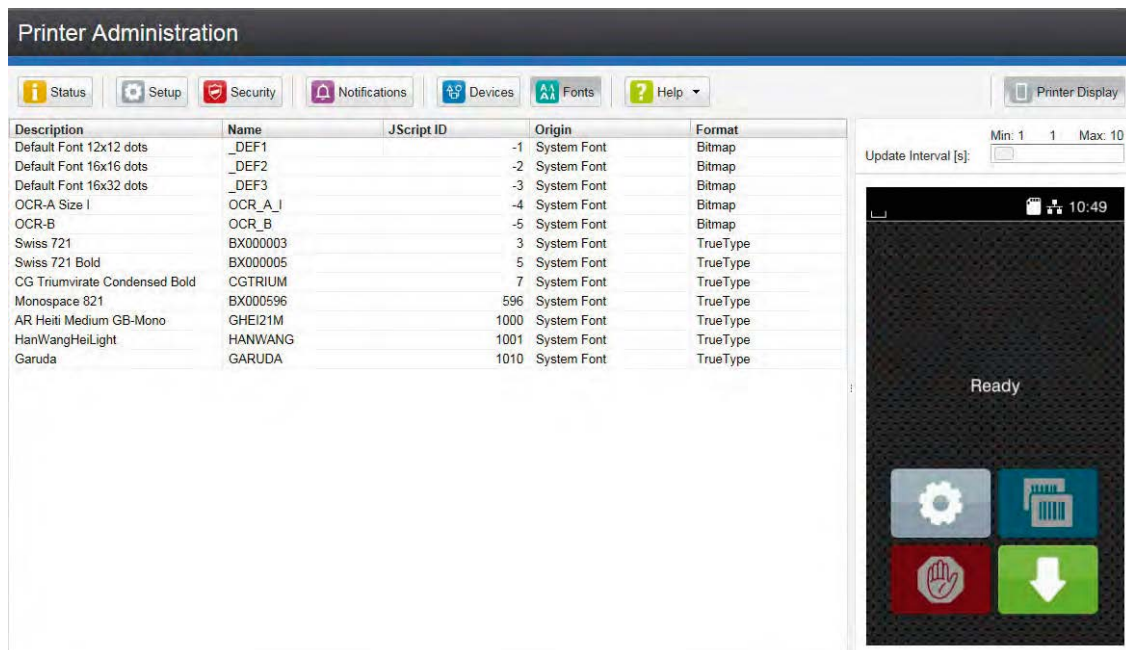

Figure 14 "Fonts" tab on the printer web interface

The parameters correspond to those in the *Font list* ▷ "Table 21" on page 37.

6.2.7 Help Menu

Independent from the chosen tab some help functions can be selected :

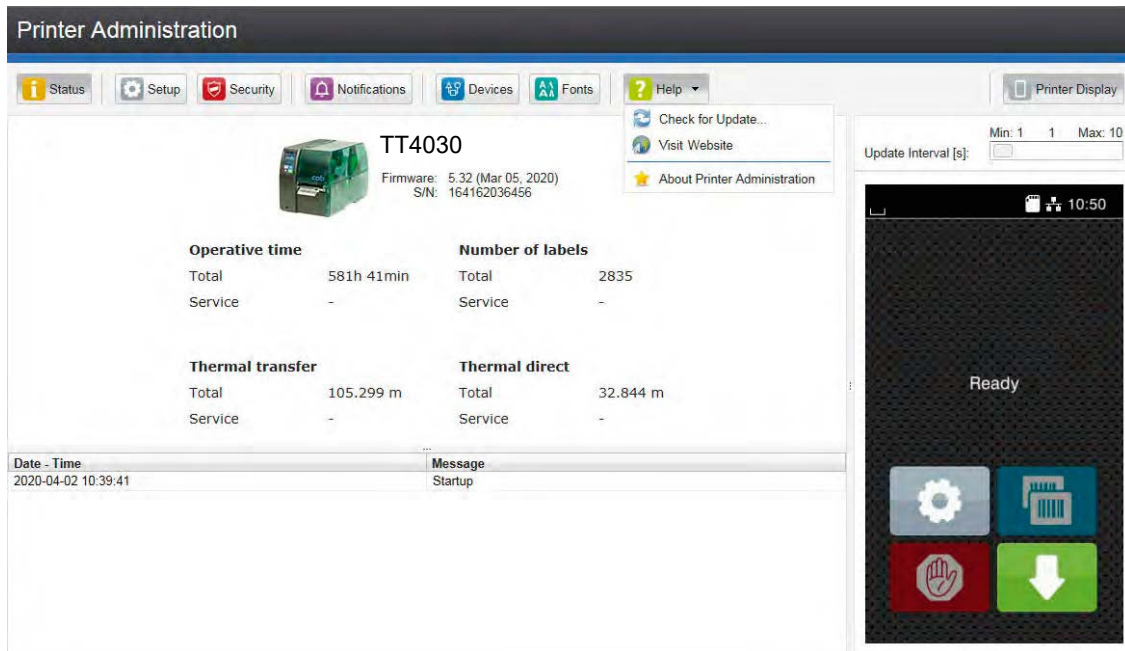
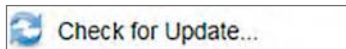

Figure 15 "Help" menu on the printer web interface



Check of the firmware version and offer for update.



Visit the HellermannTyton-Website.



Information about the version and the latest alterations of the web interface.

7.1 Overview

The  *Test* menu contains test functions providing information on:

- the most important configuration parameters
- the fonts available in the printer
- important hardware components and connected peripheral devices
- the print image quality and state of the thermal printhead
- available Wi-Fi networks.

7.2 Status Print

The *Status print* function prints a test image containing information on the configuration and status of the printer. The printout occurs using the heat level and print speed specified in the *Setup > Printing* menu.



Notice!

The printout occurs without taking the label gaps into consideration. This is why endless media are most suitable for this purpose.

- ▶ Insert printable medium (labels, endless paper) which extends across the entire printing width.
- ▶ If the printout is to occur using thermal transfer printing, insert transfer ribbon with the maximum width.
- ▶ Start menu.
- ▶ Select *Test > Status print*.

The printout can be canceled with .

Status print	
Wed Aug 14 10:48:21 2019 TT4030 Firmware V5.27 (Jul 25, 2019) - #164162036456	
Printing	
Heat level	0
Print speed	75 mm/s
Print position X	0,0 mm
Print position Y	0,0 mm
Backfeed	smart
Backfeed position	1,0 mm
Print on demand	Off
Reprint	Re-render
Single label buffer	Off
Length scale	0,0 %
Slippage correction	Off
Labels	
Label sensor	Gap
Extrapolate labels	Off
Ignore paper end	Off
Ribbon	
Transfer print	On
Warm level ribbon	32 mm
Pause on warning	Off
Monitor ink side	Off
Tearing-off	
Tear-off mode	On
Tear-off position	0,0 mm
Cutting	
Cut position	0,0 mm
Perforation level	0
Peeling-off	
Peel-off position	0,0 mm
Backfeed delay	250 ms
Labelling	
Transfer mode	Stamp on
Cycle sequence	Print-Apply
Waiting position	up
Blow time	1000 ms
Roll-on time	1000 ms
Support delay on	0 ms
Support delay off	0 ms
Start delay	0 ms
Lock time	0 ms
Vacuum delay	On
Vacuum control	On
Label hand-over	Passive
Cleaning blow	Off
Peel-off position	0,0 mm
Interfaces	
Ethernet	
Hostname	cab-999163
DHCP	Off
IP address	192.168.9.13
Netmask	255.255.255.0
Gateway	Off
DNS server	0.0.0.0
Wi-Fi	
Access Point	On cabgast
DHCP	Off
IP address	172.20.200.93
Netmask	255.255.255.0
Gateway	Off
DNS server	0.0.0.0
Network services	
FTP	On
LPD	On
RawIP	On
RawIP port	9100
RawIP timeout	Default
Website	On
Web service	On
SNMP	On
SNMP community	public
VNC server	On
Zeroconf	On
OPC UA	Off
RS-232	
Baud rate	115200
Handshake	RTS/CTS
I/O	
START mode	Edge
REPRINT mode	Edge
JOBDEL mode	Cancel print job
Start delay	0 ms
Lock time	0 ms
Legacy I/O	Off
Errors	
Error-Reprint	On
Syntax error	On
Barcode error	On
Network error	On
Region	
Language	English
Country	Germany
Keyboard	Automatic
Time	
Date	04.08.2017
Time	08:02:16
Time zone	UTC+1 (Berlin,Paris)
Daylight saving	EU
Time synchronization	NTP
Time server	
Display	
Orientation	0°
Brightness	8
Time powersave	5 min
Peripheral button	On
Reprint button	On
Pause button	On
Cancel button	On
Feed button	On
Interpreter	
Character set	UTF-8
USB	JScript
RS-232	JScript
FTP	JScript
LPD	JScript
RawIP	JScript
Bluetooth	JScript
ZPL	
Print width	100,0 mm
Label length	150,0 mm
Storage	
Default storage	SD Card
Security	
PIN protection	On
Security web service	Digest
TLS/SSL	Off
Block ext. storage	Off
Block USB ports	Off
Extras	
Cleaning interval	1000 m
Service	
Printhead zero pos. X	0,0 mm
Printhead zero pos. Y	0,0 mm
Printer Info	
Operative time	346h 55min
Total	104h 02min
Service	
Number of labels	2457
Total	1060
Service	
Thermal transfer	
Total	68,084 m
Service	20,154 m
Thermal direct	
Total	32,086 m
Service	0,080 m
Temperature	27,4 °C
Heat voltage	24,2 V
Heat level	
< 0	14,011 m
0-7	86,092 m
8-14	0,000 m
> 14	0,000 m
Label sensor	
Brightness	13-27 / 26-54

Figure 16 Status print

Parameters marked *italic* are only printed when the printer is equipped with the respective optional assembly or when the service key is inserted

7.3  Font list

The *Font list* function prints the most important parameters of the fonts available in the printer in tabular form. The table contains both the original fonts in the printer and other fonts loaded into the printer. The printout occurs using the heat level and print speed specified in the *Setup > Printing* menu.



Notice!

The printout occurs without taking the label gaps into consideration. This is why endless media are most suitable for this purpose.

- ▶ Insert printable medium (labels, endless paper) which extends across the entire printing width.
- ▶ If the printout is to occur using thermal transfer printing, insert transfer ribbon with the maximum width.
- ▶ Start menu.
- ▶ Select *Test > Font list*.

The printout can be canceled with .

Font list			
Wed Aug 14 10:44:21 2019			
TT4030			
Firmware V5.27 (Jul 25, 2019) - #164162036456			
No.	Name	Type	Description
-1	_DEF1	Bitmap	Default Font 12x12 dots
-2	_DEF2	Bitmap	Default Font 16x16 dots
-3	_DEF3	Bitmap	Default Font 16x32 dots
-4	OCR_A_I	Bitmap	OCR-A Size I
-5	OCR_B	Bitmap	OCR-B
3	BX000003	TrueType	Swiss 721
5	BX000005	TrueType	Swiss 721 Bold
7	CGTRIUM	TrueType	CG Triumvirate Condensed Bold
596	BX000596	TrueType	Monospace 821
1000	GHEI21M	TrueType	AR Heiti Medium GB-Mono
1001	HANWANG	TrueType	HanWangHeiLight
1010	GARUDA	TrueType	Garuda

Figure 17 Font list

Column	Meaning
No.	ID number of the font required for programming (command T).
Name	Name with which the font is saved internally.
Type	Type of font generation. It provides information on the variability of the font and is important when programming (command T).
Description	Explanations of the font: size, font family. The printout occurs in the appropriate font.

Table 21 Parameters of the *Font list*

7.4 Device List

The *Device list* function prints out the most important information on hardware components of the printer and connected devices. The printout occurs using the heat level and print speed specified in the *Setup > Printing* menu.



Notice!

The printout occurs without taking the label gaps into consideration. This is why endless media are most suitable for this purpose.

- ▶ Insert printable medium (labels, endless paper) which extends across the entire printing width.
- ▶ If the printout is to occur using thermal transfer printing, insert transfer ribbon with the maximum width.
- ▶ Start menu.
- ▶ Select *Test > Device list*.

The printout can be canceled with



Device list	
Wed Aug 14 10:41:19 2019 TT4030 Firmware V5.27 (Jul 25, 2019) - #164162036456	
Name	Description
CPU	X4, #164162036456 PCB-Rev. 0, FPGA-Rev. 12
TPH	4"7300dpi/Kyocera V2.1.0, #72-01165 Resistance: 1079R Mfr.: 2017-05-05 10:29:40 Firt: 2017-08-15 11:21:23 Last: 2019-09-14 07:13:08
IF 1	Ethernet 10/100 MBit/s MAC: 70:82:0e:99:91:63
IF 2	USB 2.0 Device
IF 3	RS-232
IFFS	45 MByte
USBMEM	3928 MByte
SD	3465 MByte
USB [1]	Linux 3.10.4 ehci_hcd/EHCI Host Controller High #ci_hcdrc.1, Rev. 3.10 Mfr.: 1D6B, ID: 0002, Class: 09/00, Protocol: 01 Driver: hub
USB [2]	Cypress Semiconductor Corp./USB2.0 Hub High Rev. 32.99 Mfr.: 04B4, ID: 6570, Class: 09/00, Protocol: 01 Driver: hub
USB [3]	Cambridge Silicon Radio, Ltd. Full Rev. 52.76 Mfr.: 0A12, ID: 0001, Class: E0/01, Protocol: 01 Driver: btusb
USB [4]	cab/Service-Key Full #11-10296953, Rev. 1.06 Mfr.: 0985, ID: 06D8, Class: FF/00, Protocol: FF Driver: cab_key
USB [5]	Microchip Technology Inc./AR1100 HID-DIGITIZER Full Rev. 1.01 Mfr.: 04D8, ID: 0C03, Class: 00/00, Protocol: 00 Driver: usbtid
USB [6]	Ralink/802.11 n WLAN High #1.0, Rev. 1.01 Mfr.: 148F, ID: 5370, Class: 00/00, Protocol: 00 Driver: r2800usb
USB [7]	USB /Flash Disk High #90730B001E66, Rev. 1.10 Mfr.: 13FE, ID: 1D00, Class: 00/00, Protocol: 00 Driver: usb-storage
USB [8]	Cypress Semiconductor Corp./USB2.0 Hub High Rev. 32.99 Mfr.: 04B4, ID: 6570, Class: 09/00, Protocol: 01 Driver: hub
HEALTH	PS: 24.2V, BATT OK, TPH 26, 1°C

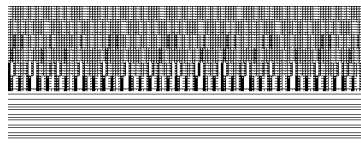

Figure 18 Device list
Parameters marked *italic* are only printed when the service key is inserted

Name	Information
CPU	Type and serial number of the PCB CPU Revision of PCB CPU and FPGA
TPH	Print width and resolution of the installed thermal printhead
IF [x]	Type of interfaces installed x : Number of interface
IFFS	Size of the Internal Flash File System
USBMEM	Size and type of an installed USB storage device
SD	Size and type of an installed SD card
USB [a] Speed	Type and revision of installed USB devices a : number of USB device Speed : data transfer speed (low, full, high) The following properties are only displayed when the service key is inserted: Mfr. : Manufacturer ID. This identifies the manufacturer of the USB device Class : Code for the USB device class Protocol : Code for the type of communication with the USB device Phase : Internal value for troubleshooting
HEALTH	Printhead voltage, charge state of the lithium battery on the PCB CPU, temperature of CPU and printhead
Line pattern	Lines differing in thickness at various distances. They are used to evaluate the print quality.

Table 22 Parameters of the *Device list*

7.5 Test Grid

The *Test grid* function prints out a geometric pattern on a background grid. This allows you to assess the evenness of the print quality.

The printout occurs using the heat level and print speed specified in the *Setup > Printing* menu.



Notice!

The printout occurs without taking the label gaps into consideration. This is why endless media are most suitable for this purpose.

- ▶ Insert printable medium (labels, endless paper) which extends across the entire printing width.
- ▶ If the printout is to occur using thermal transfer printing, insert transfer ribbon with the maximum width.
- ▶ Start menu.
- ▶ Select *Test > Test grid*.

The geometric pattern is printed every 3 seconds once the Test grid function is started.

The printout can be canceled with .

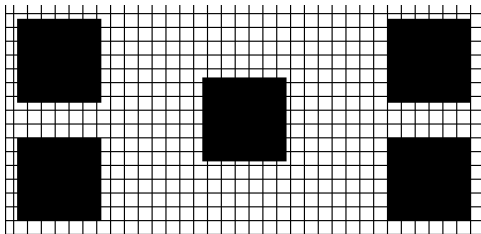

Figure 19 Test grid

7.6 Wi-Fi Status

- * **Access only when a Wi-Fi stick is installed and Wi-Fi is activated!
Not in the Wi-Fi operation mode "Hotspot".**

The *Wi-Fi status* function prints out a list with the most important parameters of the accessible Wireless Access Points. The printout occurs using the heat level and print speed specified in the *Setup > Printing* menu.



Notice!

The printout occurs without taking the label gaps into consideration. This is why endless media are most suitable for this purpose.

- ▶ Insert printable medium (labels, endless paper) which extends across the entire printing width.
- ▶ If the printout is to occur using thermal transfer printing, insert transfer ribbon with the maximum width.
- ▶ Start menu.
- ▶ Select *Test > Wi-Fi status*.

The printout can be canceled with



Wi-Fi status			
Wed Aug 14 10:36:15 2019			
TT4030			
Firmware V5.27 (Jul 25, 2019) - #164162036456			
Channel	Name/BSS ID	Signal level	Security
1	default 00:24:b2:36:98:60	●●●●●	WPA2-PSK
1	cab-firma 00:24:b2:36:98:61	●●●●●	WPA2-PSK
1	cab-gast 00:24:b2:36:98:62	●●●●●	WPA2-PSK
11	default 00:24:b2:36:98:60	●○○○○	WPA2-PSK
11	cab-firma 00:24:b2:36:98:61	●○○○○	WPA2-PSK
11	cab-gast 00:24:b2:36:98:62	○○○○○	WPA2-PSK

Figure 20 Wi-Fi status

The parameters have the following meaning :

Column	Meaning
Channel	Channel; frequency range of the Access Point
Name/BSS ID	Name of the wireless LAN MAC address of the Access Points
Signal level	Scale of the Wi-Fi signal strength
Security	Type of data encryption

Table 23 Parameters of the *WiFi status*

The  *Diagnostics* menu contains several functions for troubleshooting

8.1 Printhead

The function *Printhead* provides an overview of important status information concerning the printhead on the display of the printer.

- ▶ Start menu.
- ▶ Select *Diagnostics > Printhead*.
- ▶ Return with *Close*.

The following parameters are displayed:

Line	Meaning	Example
1	Serial number of the printhead	Serial no. 68-0252
2	Part number of the printhead	Part no. 5977444
3	Firmware revision of the printhead	Firmware 2.1.0
4	Temperature of the printhead	Temperature 26.2 °C
5	Resolution of the printhead	Resolution 12 DPMM (dots/millimeter)
6	Print width / Number of dots	Width/no. of dots 106mm/1248
7	Operative time/Number of printed labels with the current printhead	Hours/no. of labels 424h/32018
8	Previously printed paper lengths with thermal direct printing / thermal transfer printing	Thermal/Transfer 29.04m/286.42m
9	Previously printed paper length with heat level < 0	Heat level <0 44.31m
10	Previously printed paper length with heat level 0 - 7	Heat level 0-7 219.93m
11	Previously printed paper length with heat level 8 - 14	Heat level 8-14 50.41m
12	Previously printed paper length with heat level > 14	Heat level >14 0.81m
13	Resistance of the printhead	Resistance 1110Ω
14	Description of the printhead	Description 4"/300dpi/Kyocera

Table 24 *Printhead display*

8.2 Monitor Mode

Monitor Mode offers the option of checking incoming control sequences at an interface. The commands are printed out as text. In addition, a corresponding error message is printed out immediately after an error occurs.

The printout occurs using the heat level and print speed specified in the *Setup > Printing* menu.



Notice!

The printout occurs without taking the label gaps into consideration. This is why endless media are most suitable for this purpose.

- ▶ Insert printable medium (labels, endless paper) which extends across the entire printing width.
- ▶ If the printout is to occur using thermal transfer printing, insert transfer ribbon with the maximum width.
- ▶ Start menu.
- ▶ Select *Diagnostics > Monitor Mode*.
- ▶ Send print jobs.
- ▶ Select  to cancel the printout or switch to the *Ready* mode.

Example:

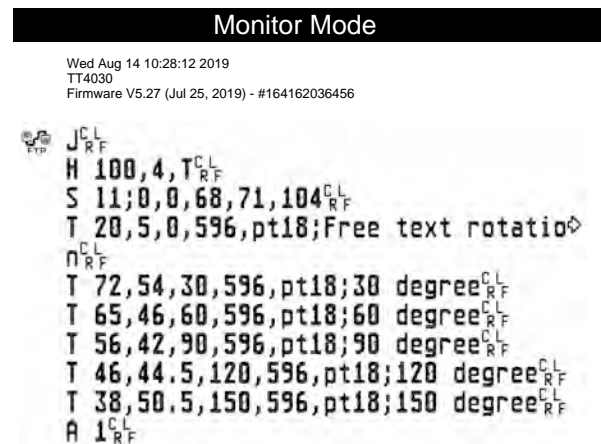
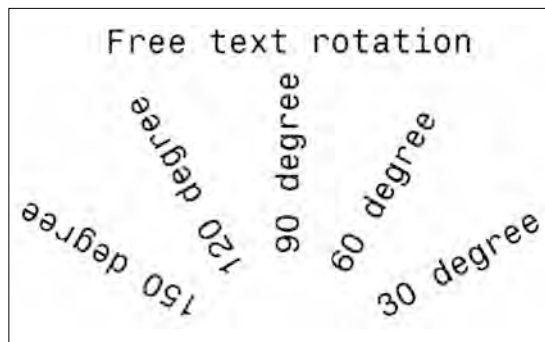

Figure 21 Example label printed normally (left) and in *Monitor mode* (right)

The control characters (ASCII-Code 00...31) are presented in stylized design.

e.g. : L_F : Code 10 (0A) - line feed

C_R : Code 13 (0D) - carriage return

8.3  Label Profile

The *Label profile* function carries out a longer label advance. It saves the values measured by the label sensor here and then prints them out in a diagram. The printout is used to check label detection in conjunction with the optical properties of the label medium. The printout occurs using the heat level and print speed specified in the *Setup > Printing* menu.



Notice!

The printout occurs without taking the label gaps into consideration. This is why endless media are most suitable for this purpose.

- ▶ Select the label sensor to be tested in the *Setup > Labels* menu ▷ page 18.
- ▶ Load the label medium to be tested into the printer.
- ▶ Start menu.
- ▶ Select *Diagnostics > Label profile*.
The printer performs a longer label advance. The label sensor measures the transparency/reflection capacity of the label material here. The message *Insert* appears in the display once the advance is complete.
- ▶ Insert printable medium (labels, endless paper) which extends across the entire printing width.
- ▶ If the printout is to occur using thermal transfer printing, insert transfer ribbon with the maximum width.
- ▶ Start the diagram printout with *Continue*.

The printout can be canceled with .

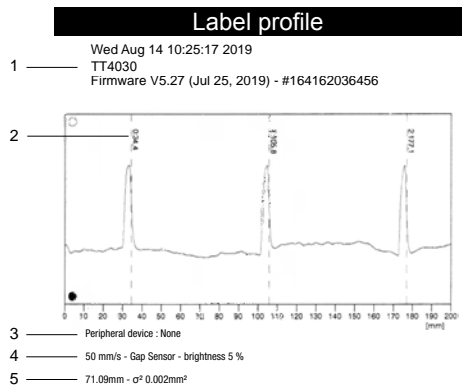

Figure 22 Label profile

No.	Information
1	Date and time of the printout Device type Version and creation date of the firmware Serial number of the PCB CPU Firmware version and serial number of the label sensor
2	Coordinate in the direction of paper flow at which the label start was detected
3	Type of peripheral device connected
4	Print speed, method of label detection (Gap sensor / Bottom-reflect sensor) Brightness of the sensor LED during the measurement
5	Average value and variation of label distances

Table 25 Information in *Label profile*

8.4 Event Log

The label printer saves the following events in the *Event log*:

- Hardware fault
- Printhead replacement
- Firmware updates
- Changing the OEM name
- Resetting of the service counters

The printout occurs using the heat level and print speed specified in the *Setup > Printing* menu.



Notice!

The printout occurs without taking the label gaps into consideration. This is why endless media are most suitable for this purpose.

- ▶ Insert printable medium (labels, endless paper) which extends across the entire printing width.
- ▶ If the printout is to occur using thermal transfer printing, insert transfer ribbon with the maximum width.
- ▶ Start menu.
- ▶ Select *Diagnostics > Event log*.



Event log	
Wed Aug 14 10:19:29 2019	
TT4030	
Firmware V5.27 (Jul 25, 2019) - #164162036456	
Date	Description
13.08.17 07:45	TPH (#59-0051) -> 300 dpi, 1248 dots
20.09.17 07:46	Firmware update -> V5.10 (0000)
04.10.17 07:38	Firmware update -> V5.11 (0000)
15.10.17 13:35	Printer model: cab SQUX 4/300MP
19.12.17 14:01	Firmware update -> V5.13 (0000)
05.09.18 11:38	Clear service counters
05.09.18 11:38	Cleaning interval -> 41242 + 1000000
13.08.19 07:42	Firmware update -> V5.27 (0000)

Figure 23 Event log

8.5  Record Data Stream

* Access only with external storage device!

The function *Record data stream* allows to store data incoming via an interface as an .lbl file to an external storage device (SD card, USB memory module) installed on the printer.

- ▶ Insert SD card or USB memory module.
- ▶ Start menu.
- ▶ Select *Diagnostics > Record data stream*.
- ▶ Select the external storage device.
- ▶ Enter a file name.
The predefined name is composed of the identifier "log", date, clock time and the suffix ".lbl", but may also be altered.
Confirm the selection with .
- ▶ In the status line of the display the data saving is indicated by the symbol .
- ▶ Send print jobs. All data received by the printer are stored in the .lbl file.
- ▶ To complete the function select *Diagnostics > Record data stream* again and confirm with OK. The .lbl file will be stored in the root of the storage device.

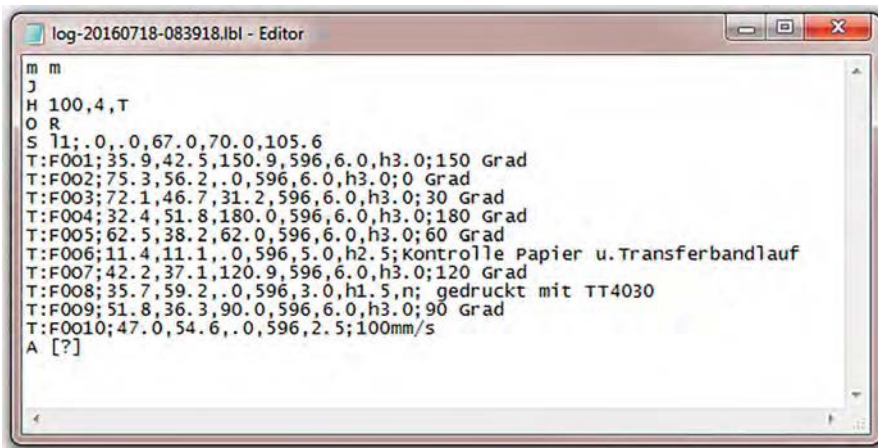



Figure 24 Data stream record

8.6 Save Print Image

* Access only with external storage device!

The function *Save print image* allows to store the last print image as a .png file to an external storage device (SD card, USB memory module) installed on the printer.

- ▶ Insert SD card or USB memory module.
- ▶ Start menu.
- ▶ Select *Diagnostics > Save print image*.
- ▶ Select the external storage device.
- ▶ Enter a file name.
The predefined name is composed of the identifier "img", date, clock time and the suffix ".png", but may also be altered.
- ▶ Confirm the selection with . The .png file will be stored in the root of the storage device.

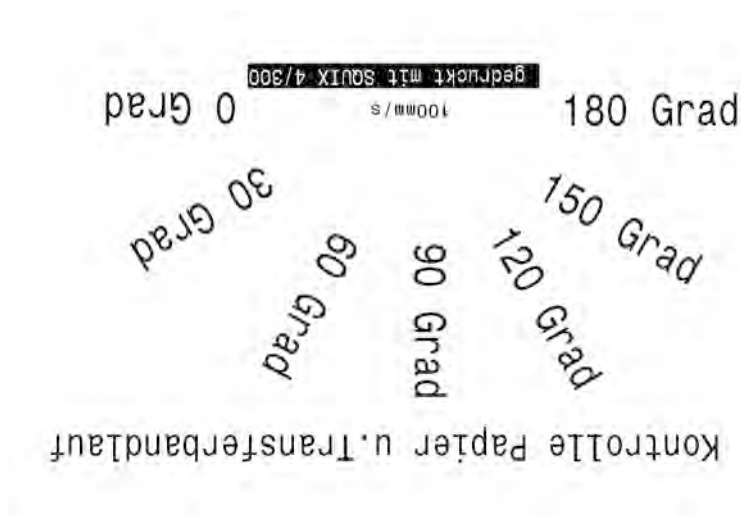

Figure 25 Saved print image

8.7 Save System Log

* Access only with external storage device!

The function *Save system log* allows to store several system files packed to a .zip file to an external storage device (SD card, USB memory module) installed on the printer.



- ▶ Insert SD card or USB memory module.
- ▶ Start menu.
- ▶ Select *Diagnostics > Save system log*.
- ▶ Select the external storage device.
- ▶ Enter a file name.
The predefined name is composed of the identifier "sys", date, clock time and the suffix ".png", but may also be altered.
- ▶ Confirm the selection with . The display shows the several steps of saving.



Figure 26 System log saving

- ▶ Confirm the completion of saving with . The .zip file will be stored in the root of the storage device.

9.1 Firmware Update



Notice!

The firmware file can be obtained from the internet.

* Access only with external storage device!

- ▶ Copy the firmware file to the "misc" directory of the storage device. This can be done on a computer or via FTP on the printer.
- ▶ Insert the prepared storage device into the printer.
- ▶ Start menu.
- ▶ Select *Extras*.
If the menu is protected via a PIN a prompt appears in the display. Enter the code number and confirm it.
- ▶ Select *Firmware update*.
The display shows the selection of external storage devices and the firmware files stored on the devices.
- ▶ Select a file and confirm with  .
The selected firmware file is copied. A progress indicator is displayed while the firmware is being copied. After completion the printer will be re-started.



Notice!

The firmware update also can be done via FTP printer management ▷ "12.4" on page 55.

9.2 Save Settings

With the *Save settings* function the printer configuration can be saved to a storage device.

- ▶ Start menu.
- ▶ Select *Extras*.
If the menu is protected via a PIN a prompt appears in the display. Enter the code number and confirm it.
- ▶ Select *Save settings*.
- ▶ Select the external storage device.
- ▶ Enter a file name.
The predefined name is composed of the identifier "gui", date, clock time and the suffix ".xml", but may also be altered.
- ▶ Confirm the selection with  . The .xml file will be stored in the folder /misc of the storage device.

An error message appearing during the saving procedure may be caused by an unreadable medium (e.g. unknown medium, unformatted medium) ▷ "13.5.4" on page 58.

9.3 Load Settings

A printer configuration previously saved to a storage device can be loaded with the *Load settings* function.

- ▶ Start menu.
- ▶ Select *Extras*.
If the menu is protected via a PIN a prompt appears in the display. Enter the code number and confirm it.
- ▶ Select *Load settings*.
- ▶ Select the desired file.
- ▶ Confirm the selection with  . Loading of the configuration data starts. Do not remove the USB flash drive until the loading procedure is complete. The printer returns to the *Extras* menu.

If an error occurs during the loading procedure, an error message appears in the display. Restart the loading procedure in this case. If an error occurs again, the configuration parameters must be entered via the control panel.

9.4 Reset Settings

With the *Default settings* function all setup parameters excepting the passwords ▷ page 16 can be reset to the default values.

- ▶ Start menu.
- ▶ Select *Extras*.
If the menu is protected via a PIN a prompt appears in the display. Enter the code number and confirm it.
- ▶ Select *Reset settings*.
The display shows "Reset settings".
- ▶ Select *Continue*. The setup parameters will be reset and printer returns to the *Extras* menu.

9.5 Reset Passwords

The function *Reset passwords* allows to reset all passwords for the network services to the default values.

- ▶ Start menu.
- ▶ Select *Extras*.
If the menu is protected via a PIN a prompt appears in the display. Enter the code number and confirm it.
- ▶ Select *Reset passwords*.
The display shows "Reset passwords".
- ▶ Select *Continue*. The passwords will be reset and printer returns to the *Extras* menu.

Function	User name	Password
Web interface access	admin	admin
FTP printing	ftpprint	print
FTP access to storage devices	ftpcard	card
FTP firmware update	ftpadmin	admin
Web service	soap	soap
OPC networking	opcuser	opcpass

Table 26 Default passwords

9.6 Cleaning Interval

With the parameter *Cleaning interval* an interval for the printhead cleaning can be set in steps of 100 m media passage.

If the set length of the medium (label strip, transfer ribbon) has passed the printhead and an error occurs in the flow of the medium (e.g. label end, transfer ribbon end), the *Clean printhead!* message appears in the display.

The error message for the error which occurred is not displayed until the *Clean printhead!* message is acknowledged. As long as no errors occur in the medium flow, no messages are displayed and the print job is continued even if the cleaning interval has passed.

- ▶ Start menu.
- ▶ Select *Extras*.
If the menu is protected via a PIN a prompt appears in the display. Enter the code number and confirm it.
- ▶ Select *Cleaning interval*.
- ▶ Select a new value and confirm the selection with .

9.7

**Legal Notices**

The *Legal notices* function shows the licenses and software libraries of third party solutions used in the printer firmware.

- ▶ Start menu.
- ▶ Select *Extras*.
If the menu is protected via a PIN a prompt appears in the display. Enter the code number and confirm it.
- ▶ Select *Legal notices*.
The notices will be shown on the display
- ▶ Select *Close* to leave the notices.

The *Help* menu contains links to video clips about important operations.

- ▶ Start menu.
- ▶ Select *Help*.
A list of clips will be shown.

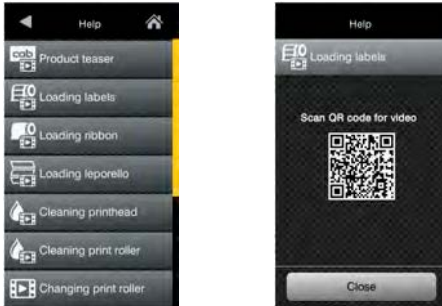

Figure 27 Help

- ▶ Select a clip.
The display shows a QR code which can be scanned by a mobile device.
If the mobile device is connected to the internet a video clip with the selected content will start.

11.1 Reset Service Counter



Access only with service key inserted!

The printer has total and service counters.

- Total counter: The total counter contains the values for the entire service life of the printer up to now. The values of the total counter are displayed in the *Info* menu and in the *Status print*.
- Service counter: The service counter can be reset after more substantial maintenance or repair work with the service key inserted. Here, it provides information on the printing output since the last reset. The values of the service counter are displayed in the *Status print*.

The following data is recorded in both counters:

Data	Description
Operative time	Printer switch-on time
Number of labels	Number of labels printed
Transfer printing	Length of medium printed with transfer printing
Thermal printing	Length of medium printed with thermal direct printing

Table 27 Total and service counter data

- ▶ Insert service key into an USB host interface.
- ▶ Start menu.
- ▶ Select *Service > Reset service counter*.
The display shows *Reset service counter*.
- ▶ Select *Continue*. The data recorded by the service counter is set to the value 0.

The status print can be used to check whether the values were reset.

11.2 Printhead Zero Position X



Access only with service key inserted!

The purpose of the *Printhead zero pos. X* setting is to fundamentally align the printing image to the printhead perpendicular to the printing direction in order to compensate for printhead tolerances.

- ▶ Determine the deviation of the actual from theoretical position of the printing image perpendicular to the printing direction.
- ▶ Select menu *Service > Printhead zero pos. X*.
- ▶ Choose a setting that counteracts deviation.

11.3 Printhead Zero Position Y



Access only with service key inserted!

The purpose of the *Printhead zero pos. Y* setting is to fundamentally align the printing image to the printhead in the printing direction in order to compensate for printhead tolerances.

- ▶ Determine the deviation of the actual from theoretical position of the printing image in the printing direction.
- ▶ Select menu *Service > Printhead zero pos. Y*.
- ▶ Choose a setting that counteracts deviation.

11.4 Printer Model

Access only with service key inserted!

With the *Printer model* function the firmware can be adapted to the device type.

- ▶ Start menu.
- ▶ Select *Service > Printer Model*.
- ▶ Select a model.

Following the *Info* function, all test prints and the web interface show the selected printer model.

11.5 No Branding

Access only with service key inserted!

With the activation of the *No branding* parameter the Logo in the display can be suppressed.

▷ "3.2" on page 12

- ▶ Start menu.
- ▶ Select *Service > No branding*.
- ▶ Activate the parameter.

The File Transfer Protocol (FTP) allows to manage and transfer files on the network via the Ethernet interface or Wi-Fi adapter. An FTP program (FTP client) is required which supports the "binary" transfer mode to manage the printer. The printer functions as an FTP server.

FTP printer management is comprised of four functions:

- Direct printing via copying JScript or ZPL files.
- Management of the memory media installed in the label printer
- IFFS management
- Firmware update.

12.1 FTP Login

To establish an FTP connection, the client must be logged on to the server. The login type depends on the client. The following information must be specified in any case, however:

- IP address of the label printer
- User name and password

Access to the printer management functions depends on the user name:

Function	User name	Default password
FTP printing, loading PPP vouchers	ftpprint	print
FTP access to storage devices	ftpcard	card
FTP firmware update	ftpadmin	admin

Table 28 Default passwords



Notice!

- ▶ The passwords can be changed in the "Setup" tab of the web interface ▷ page 32.

After logging on the FTP server is accessible in a manner similar to a Windows folder.

12.2 FTP Printing

Label files in cab JScript format (▷ Programming Manual) or in ZPL format can be printed directly via FTP connection:

- ▶ Establish a FTP connection with the user name **ftpprint** and the defined password (Default: **print**)
An empty folder of the FTP server will be shown.
- ▶ Copy a label file in JScript or ZPL format to the folder of the FTP server.
Printing of the label file is started immediately. The corresponding file is deleted once the print job is complete.
- ▶ Close the FTP connection.

12.3 FTP Access to Storage Devices

FTP connection allows to manage data of a storage device:

- ▶ Establish a FTP connection with the user name **ftpcard** and the defined password (Default: **card**).
The content of the storage device will be shown. The files are separated into several subfolders.
- ▶ Manage the files as necessary. When copying files to the folder, type-based sorting occurs automatically in the subfolders.
- ▶ Close the FTP connection.

12.4 FTP Firmware Update

FTP allows to carry out a firmware update:

- ▶ Establish a FTP connection with the user name **ftpadmin** and the defined password (Default: **admin**).
An empty folder of the FTP server will be shown.
- ▶ Copy a valid firmware file (e.g. 527_9725.cfw) to the folder.
The status of the saving procedure is shown by a progress indicator in the display. The printer resets automatically after the update is carried out successfully.
- ▶ Close the FTP connection.

Whether the firmware update was carried out successfully can be checked on the "Status" tab of the web interface.

Label descriptions, graphics, fonts, and database information can be saved for the long-term on memory media.



Notice!

- ▶ **Always create a backup copy of external devices in case of a malfunction.**

13.1 Suitable Storage Devices

External Devices

- USB flash drive at USB host interface.
- SD cards

Internal Device

- approx. 50 MB flash memory inside the printer (Internal Flash File System IFFS)

13.2 Installation

*** For external storage devices only!**

- ▶ Slide SD card contact-side first into the matching slot until it latches. To unlatch SD card press it shortly into the slot and remove it.
or
- ▶ Connect USB flash drive to an USB host interface.



Attention!

Risk of data loss !

- ▶ **Do not remove the storage device while it is being accessed.**

13.3 Directory Structure

On storage devices connected to the printer, the following directory structure is automatically generated when uploading files:

Folder name	Contents
fonts	Font files
images	Graphic files
labels	Label description files
misc	Firmware, PPP, Setup and TMP files

Table 29 Directory structure

13.4 Writing

The storage devices can be written to in several ways. The most functionally secure way is writing to the storage device via a data interface.



Attention!

The device selected as *Default storage* is written to by default. To write to another device specify the path name of the device in the file name (▷ Programming Manual).

Example:

With direct programming, the command sequence for saving a label (file XYZ) has the following form:



Ms LBL; XYZ	Command for saving the file XYZ
J	
H 100,0,T	
S I1;0,0,68,71,104	Contents of the file XYZ
T 10,10,0,3,pt15;memory card	
A 1[NOPRINT]	
Ms LBL	End of save command

- After transfer of the command sequence, the file XYZ is saved with the commands from J to A.
- Only one label is printed each time the file XYZ is called up.
- The [NOPRINT] parameter in command A suppresses the printing of a label when the file is saved.
- To print the label a variable number of times, use command A [?].

13.5 Storage Device Functions

13.5.1 Load Label

Labels whose descriptions are saved on the storage device can be printed using the *Load label* function.

- ▶ Start menu.
- ▶ Select *Storage > Load label*.
The display shows the selection of external storage devices and the label files stored on the devices.
- ▶ Select a label and confirm with .
If a label is selected which was saved with a fixed contents and fixed label quantity, the print job is started immediately.
If additional input on the label description is required, the display requests to enter the variable data.
For label descriptions with a variable label quantity, a prompt to enter the label quantity is displayed.
- ▶ Enter the label quantity/variable data and select  to start the print job.

13.5.2 Print File List

The *Print file list* function creates a list of the files stored on the default storage device.



- ▶ Insert printable medium (labels, endless paper) which extends across the entire printing width.
- ▶ If the printout is to occur using thermal transfer printing, insert transfer ribbon with the maximum width.
- ▶ Start menu.
- ▶ Select *Storage > Print file list*
The display shows the selection of storage devices
- ▶ Select a storage device and confirm with .
The directory of the storage device will be printed.

Contents of the printout:

- the name of the storage device
- information on the saved files
- the size of the available memory area

13.5.3 Copy Files

With the *Copy files* function files can be copied from one to another storage devices.

- ▶ Insert the storage devices.
- ▶ Start menu.
- ▶ Select *Storage > Copy files*.
Under the headline *Source* the selection of storage devices will be shown.
- ▶ Select source device.
- ▶ Select a folder.
- ▶ Select files. One single file or all files (*.*) of the folder can be selected.
- ▶ Confirm the selection with .
Under the headline *Destination* the selection of storage devices will be shown again.
- ▶ Select destination device and folder.
- ▶ Confirm the selection with .
The files are copied. The display shows the message "*Copied ... file(s) to [Destination]*"
- ▶ Select *Continue* to return to the *Storage* menu.

13.5.4 Format Storage

The *Format* function can be used to delete all data from a storage device. This reformats the storage device. So you can also use the *Format* function if the *Unknown card* error message appears when using the device.

- ▶ Insert storage device
- ▶ Start menu.
- ▶ Select *Storage > Format storage*.
If the function is protected via a PIN a prompt appears in the display. Enter the code number and confirm with *OK*.
The display shows the selection of storage devices.
- ▶ Select a storage device and confirm the selection with .
The display shows the message *All data on the selected device will be lost*.
- ▶ Select *Continue*. The storage device will be formatted.
Do not remove the device from the printer during the deleting procedure.
The printer returns to the *Storage* menu.

13.5.5  **Default Storage**

With the parameter *Default storage* Definition the storage device can be defined, which can be operated via interfaces and FTP printer management.

At functions started from the printer display all storage devices are accessible, but the default storage will be offered first.

- ▶ Start menu.
- ▶ Select *Storage > Default storage*.
The display shows the selection of storage devices.
- ▶ Select a storage device and confirm the selection with  .

**Attention!**

For the remote access via VNC the firmware version 5.03 or later must be installed.

VNC is a software that allows remote control of a printer's operation control panel (server) via a computer (client) through input devices like keyboard and mouse.

VNC is not platform dependent and enables the use of a Windows computer as well as a mobile Android or iOS system as an external remote control. The prerequisite for this is the installation of a VNC client on the system used.

Preparing the Computer

- ▶ Install the VNC client on the computer.

Preparing the Printer

- ▶ Activate the VNC server under *Setup > Interfaces > Network services > VNC server*.
- ▶ Enter password *vnc* under *Security > Password VNC*.

For Wireless Access:

- ▶ Activate Wi-Fi under *Setup > Interfaces > Wi-Fi > Wi-Fi*.
- ▶ Find out the Wi-Fi-IP-Address under *Info*.

For Ethernet Access:

- ▶ Find out the Ethernet-IP-Address under *Info*.

Establishing a Connection

- ▶ Start the VNC client on the computer.
- ▶ Enter the IP address and password *vnc* in the configuration of the VNC client.
- ▶ Activate the connection.
The menu of the printer will be visible and usable via mouse click, keyboard or touch-pad just like on the printer itself.

An external keyboard or a compatible input device (e.g. barcode scanner) can be connected directly to the printer. Using an external keyboard facilitates the entry of variable data while processing print jobs and printing from storage devices.

Input prompts and the data received from the keyboard are shown in the display.

15.1 Connecting External Keyboard

Any HID compatible USB keyboard can be connected to the printer.

- ▶ Insert connection cable of the keyboard into a USB host interface of the printer.

15.2 Keyboard Assignment

- ▶ If necessary set the parameter *Setup > Region > Keyboard* matching to the used keyboard.



Notice!

- ▶ **If the parameter *Keyboard* is set to *Automatic*, the keyboard assignment will be defined by the setting of the parameter *Country*.**

The following *Country* settings have special keyboard assignment :

Country	Keyboard
China	USA
South Africa	USA
Taiwan	USA
Mexico	Latin America
Egypt	Arabic

Table 30 Special assignments *Country - Keyboard*

For the following *Keyboard* settings can be switched between two assignments by pressing the CTRL key and the SHIFT key:

Keyboard	First assignment	Second assignment
Bulgaria	Latin	Cyrillic
Greece	Latin	Greek
Iran	Latin	Persian
Macedonia	Latin	Cyrillic
Russia	Latin	Cyrillic
Thailand	Latin	Thai
Arabic	Latin	Arabic

Table 31 *Keyboard* settings with double assignment

15.3 Special Key Functions

General :





[F1]	Executes the <i>Load label</i> storage device function.
[F2]	Prints an additional label from the last print job. Corresponds to  .
[F3]	Repeats the last print job with renewed polling of the variable data and polling of the label quantity.
[F8]	Functions like  .
[Enter]	Starts menu
[Esc]	Functions like  .
[Space]	Functions like  .

Table 32 Special key functions: general

In the menu and for entry of variable data:

[Enter]	Confirms the input.
[Esc]	Cancels the input and returns.
[Shift][Entf]	Clears the input line.

Table 33 Special key functions: Menu and data input



Attention!

When using a scanner operated as keyboard emulation ensure that the same character set is set for both the scanner and the printer.

- A**
- Apply/Print 22
- B**
- Backfeed 17
 - Backfeed position 17
 - Baud rate 25
 - Blowing air 22
 - Blow on 22
 - Blow time 22
 - Bluetooth 10, 28
 - Brightness 27
- C**
- Character set 28
 - Cleaning interval 49
 - Connecting to computer 6
 - Control characters 42
 - Country 26
 - Cutting 21
- D**
- Date 26
 - Daylight saving 27
 - Device list 38
 - Devices tab 34
 - DHCP 23, 24
- E**
- Errors 26
 - Ethernet 23
 - Ethernet interface 6, 7
 - Event log 44
 - Extrapolate labels 18
- F**
- Firmware update
 - from storage device 48
 - via FTP 55
 - via web interface 35
 - Firmware version 30
 - Font list 37
 - Font tab 34
 - Format storage 58
 - FTP 54
 - FTP login 54
 - FTP server 54
- G**
- Gateway 23, 24
- H**
- Heat level 17
- I**
- IFFS 54, 56
 - Important information 5
 - Interfaces 23
 - Interpreter 28
 - IP 23, 24
- J**
- JScript 28
- K**
- Keyboard 61
 - Key functions 62
- L**
- Labelling 22
 - Label profile 43
 - Labels 18
 - Label sensor 18
 - Legal notices 50
 - Load label 57
 - Load settings 48
- M**
- Menu 11
 - Monitor mode 42
- N**
- Network services 25
- P**
- Passwords 54
 - Peeling-off 21
 - Print/Apply 22
 - Printing 17
 - Printing intensity 17
 - Print offset 17
 - Print services 7
 - Print speed 17
 - Protocol 25
- R**
- Raw-IP 7
 - Record data stream 45
 - Region 26
 - Register Geräte 33
 - Reset service counter 52
 - Reset settings 49
 - Ribbon 20
 - Roll on 22
 - Roll-on time 22
 - RS-232 25, 28
- S**
- Save print image 46
 - Save settings 48
 - Security tab 32
 - Service key 14
 - Setup tab 31
 - Single print mode 18
 - Stamp on 22
 - Starting position 22
 - Status print 36
 - Status tab 30
 - Storage device functions 57
 - Storage devices
 - Directory structure 56
 - Installation 56
 - Print labels 57
 - Writing 57
 - Supporting air 22
 - Switch-off delay 22
 - Switch-on delay 22
- T**
- Tearing-off 20
 - Tear-off mode 20
 - Tear-off position 20
 - Test grid 39
 - Time 27
 - Time powersave 27
 - Transfer print 20
- U**
- USB device interface 6
 - USB host interface 6
 - USB memory 56
- V**
- Vacuum sensor 22
 - VNC 60
- W**
- Waiting position 22
 - Web interface 29
 - Wi-Fi 24
 - Wi-Fi status 40
 - Windows printer setting 7
- Z**
- ZPL 28